

Item # _____
 Project : _____
 Qty : _____

Single Pot Hook Racks

Model No. **SW1-96-CWP-8**

Additional Sizes	SW1-24-CWP-8	SW1-48-CWP-8	SW1-72-CWP-8
	SW1-36-CWP-8	SW1-60-CWP-8	SW1-96-CWP-8

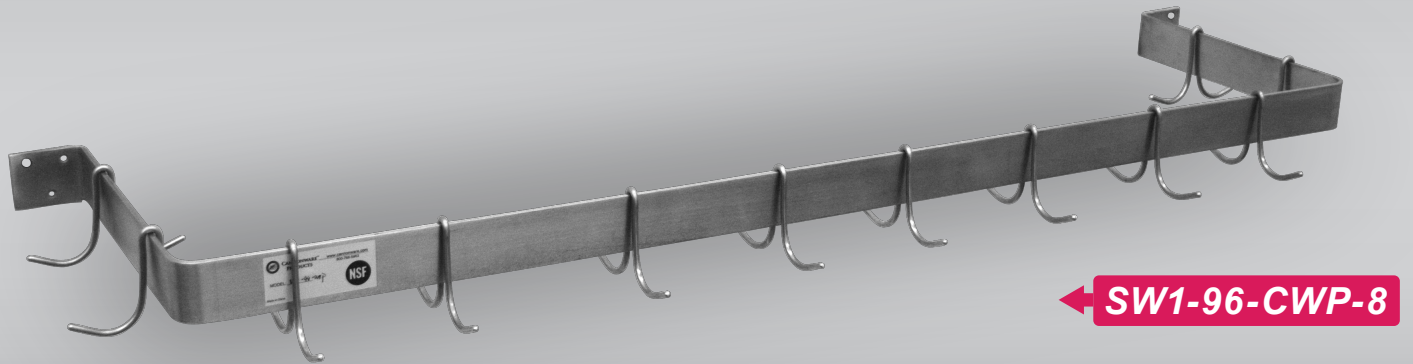

Features:

- 304 Series Stainless Steel.

Warranty Info:

- See Last Pages



Revised **04/24/2024**



SW1-96-CWP-8	SW1-24-CWP-8	SW1-60-CWP-8
	SW1-36-CWP-8	SW1-72-CWP-8
	SW1-48-CWP-8	SW1-96-CWP-8

www.servware.com
 Phone:(800).768.5953
 Fax:(800).976.1299



Side View

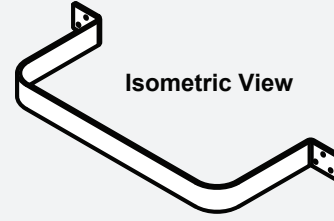

Isometric View

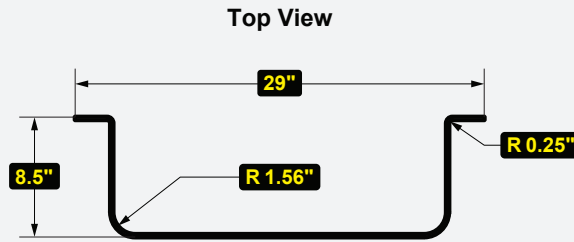

Top View

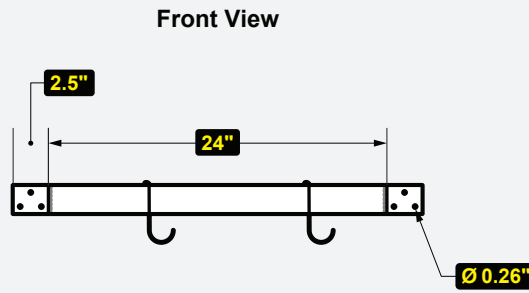

Front View

MODEL #	DESCRIPTION	DIMENSIONS	WEIGHT/LBS.
		(W x D x H)	(Shipping)
SW1-24-CWP-8	24" Bar w/ 2 Hooks	29" W x 8.5" D x 2" H	7 lbs.

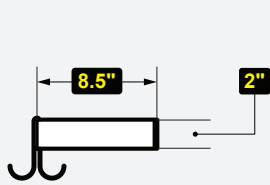

Side View

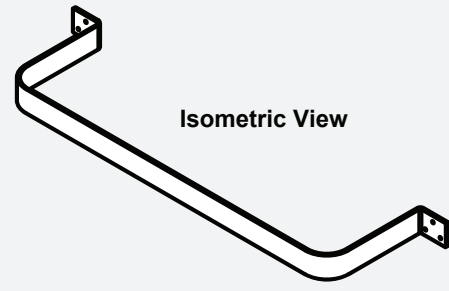

Isometric View

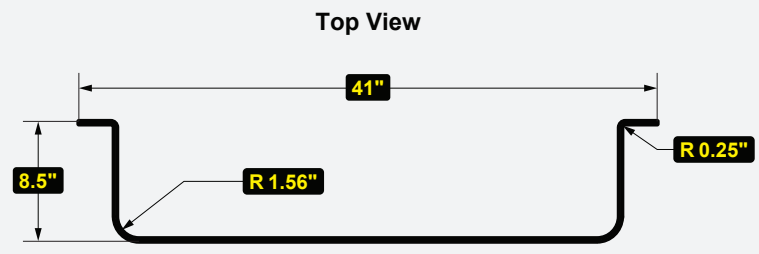

Top View

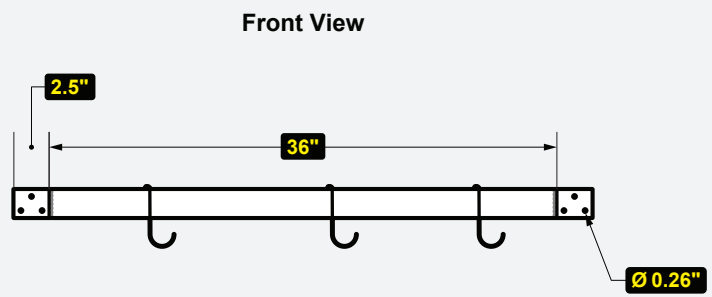

Front View

MODEL #	DESCRIPTION	DIMENSIONS	WEIGHT/LBS.
		(W x D x H)	(Shipping)
SW1-36-CWP-8	36" Bar w/ 3 Hooks	41" W x 8.5" D x 2" H	10 lbs.



Prop. 65 Warning for California Residents
 WARNING: This product may contain chemicals known to the State of California to cause cancer, birth defects, or other reproductive harm.

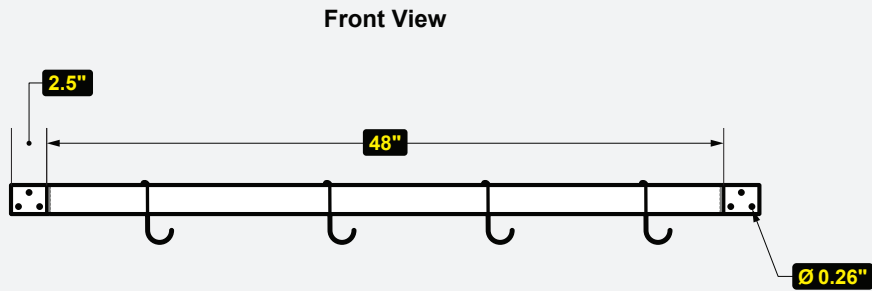
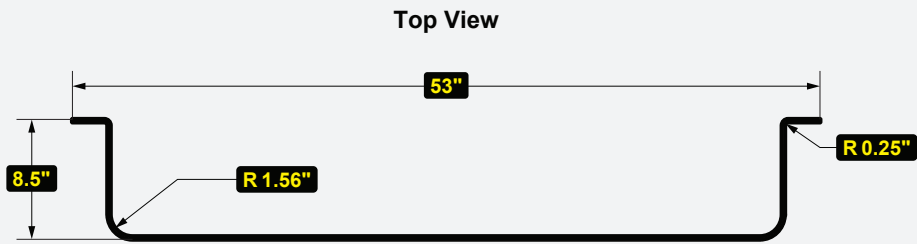
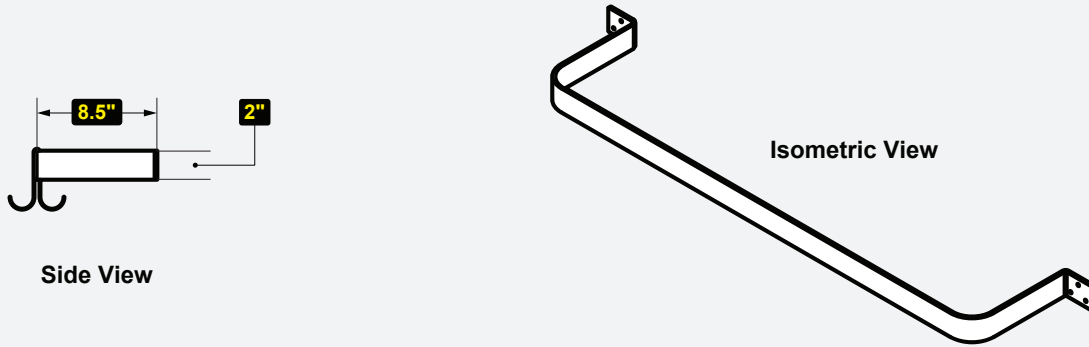

MODEL #	DESCRIPTION	DIMENSIONS	WEIGHT/LBS.
		(W x D x H)	(Shipping)
SW1-48-CWP-8	48" Bar w/ 4 Hooks	53" W x 8.5" D x 2" H	12 lbs.

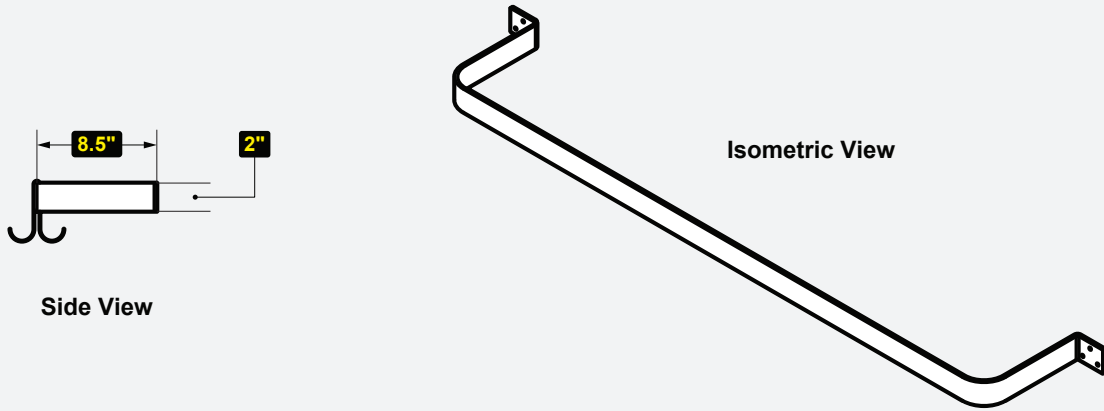

Side View

Isometric View

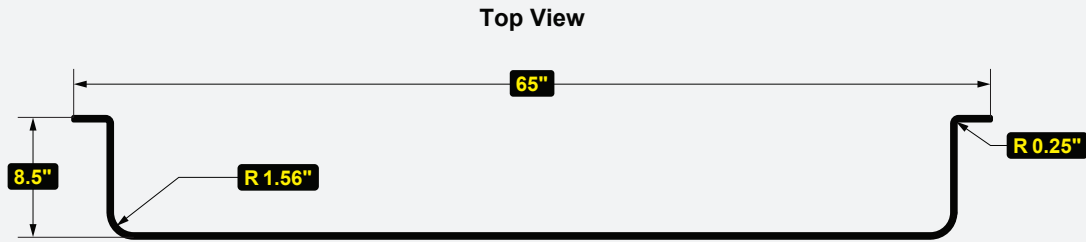

Top View

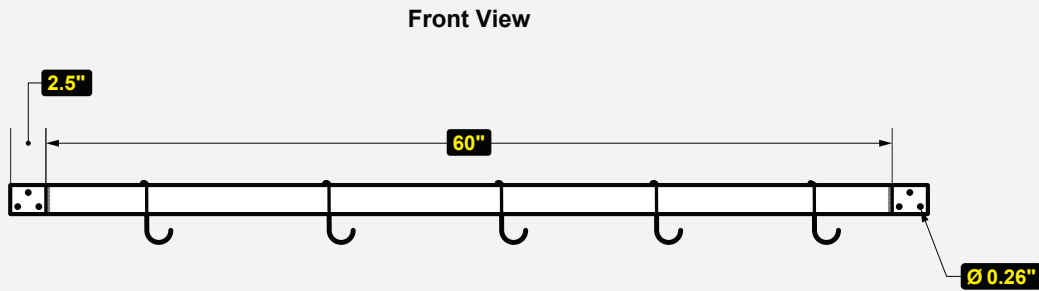

Front View

MODEL #	DESCRIPTION	DIMENSIONS	WEIGHT/LBS.
		(W x D x H)	(Shipping)
SW1-60-CWP-8	60" Bar w/ 5 Hooks	65" W x 8.5" D x 2" H	15 lbs.

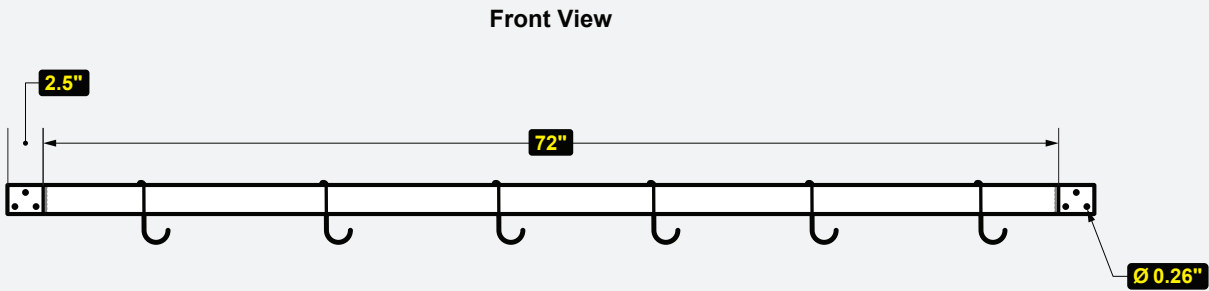
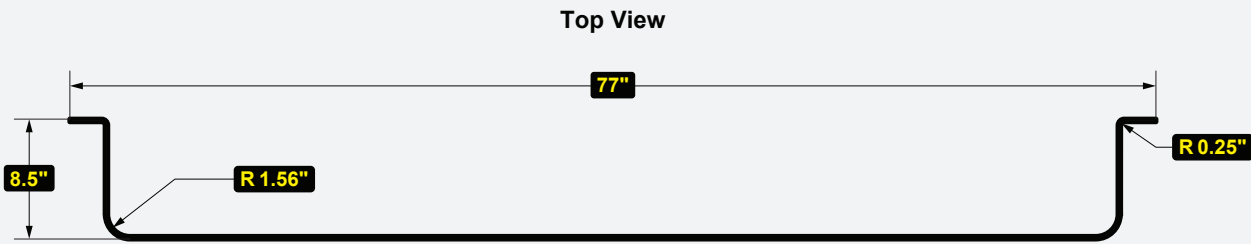
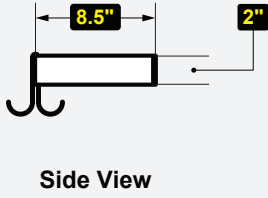
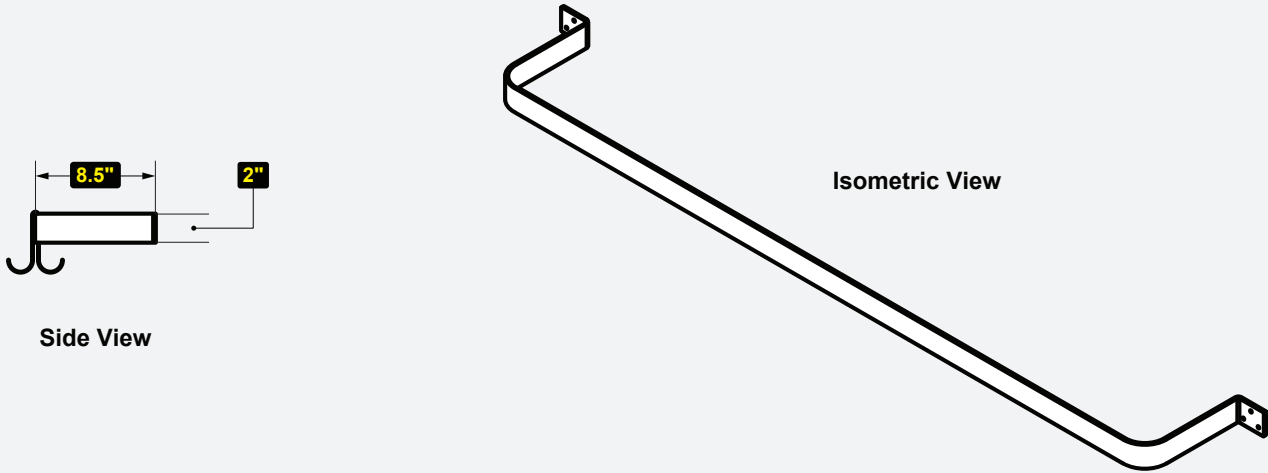

MODEL #	DESCRIPTION	DIMENSIONS	WEIGHT/LBS.
		(W x D x H)	(Shipping)
SW1-72-CWP-8	72" Bar w/ 6 Hooks	77" W x 8.5" D x 2" H	22 lbs.

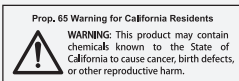

Phone:(800).768.5953
 Fax:(800).976.1299

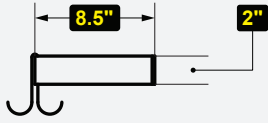

Side View

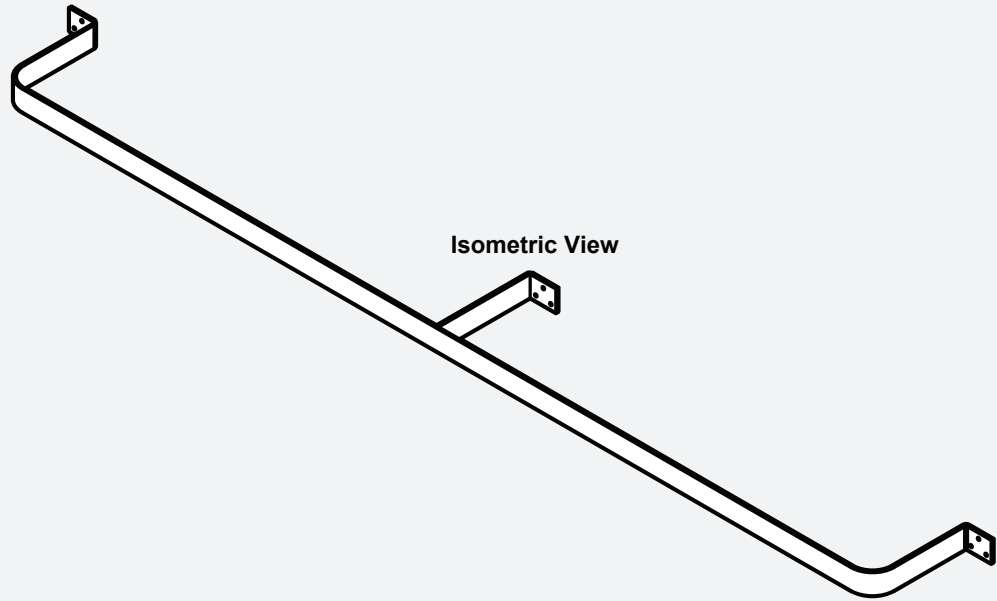

Isometric View

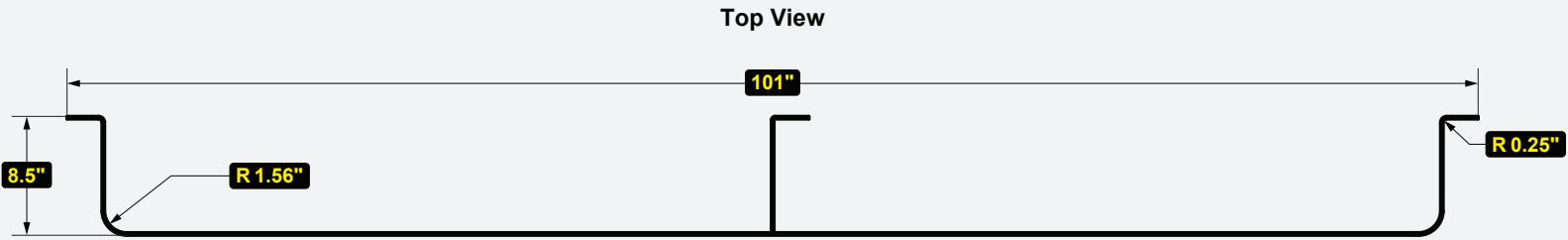

Top View

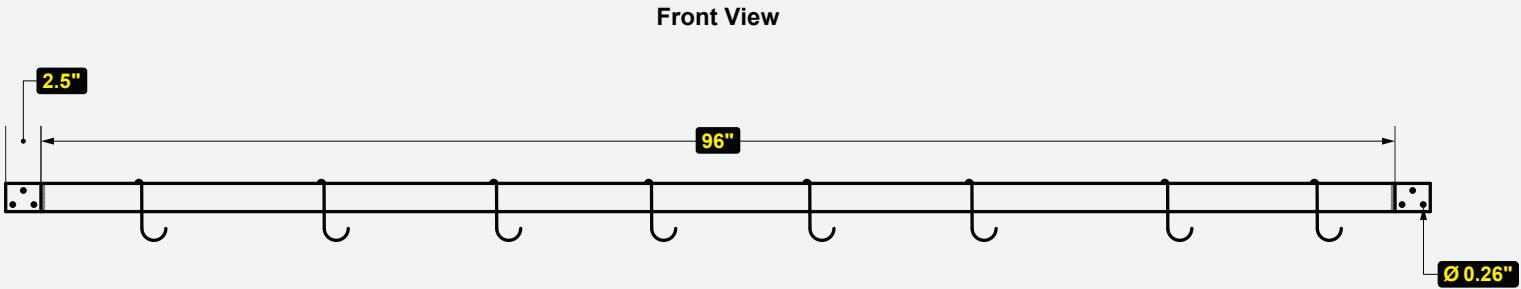

Front View

MODEL #	DESCRIPTION	DIMENSIONS	WEIGHT/LBS.
		(W x D x H)	(Shipping)
SW1-96-CWP-8	96" Bar w/ 8 Hooks	101" W x 8.5" D x 2" H	25 lbs.

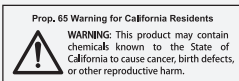

Serv-Ware Sinks & Accessories

Notify carrier of damage! Inspect all components immediately.

Serv-Ware Products warrants to the original owner/user that any product manufactured shall be free of defects in material or workmanship, under normal use and maintenance, for a period of one (1) year from the original installation date or a maximum of eighteen (18) months after the shipment date from Serv-Ware Products. Proper installation and start-up in accordance with the instruction manual supplied will be taken into consideration when evaluating the warranty on the specified equipment.

This warranty does not include labor charges. Serv-Ware Products reserves the right to have any warranty "failed" parts returned to the factory for inspection before agreeing to covering the above stated warranty.

This warranty does not include parts coverage resulting from:

- Adverse operating conditions for the product.
- Failure to clean and/or maintain the product.
- Standard wear & tear items.
- Damage that is caused by employees or customers.
- Any part or assembly that has been altered, modified, or changed.
- Equipment usage in a residential or non-commercial setting.

LIMITATION OF LIABILITY AND OTHER WARRANTIES

Serv-Ware Products assumes no liability for misuse or inadequate maintenance of the Product. In no event shall the user be entitled to recover incidental or consequential damages. Including but not limited to; damages for inconvenience, food loss, rental or replacement equipment, loss of profits, or other commercial loss.

Warranties stated above are the only warranties made in connection with the sale and distribution of the Products. ANY AND ALL OTHER EXPRESSED STATUTORY AND IMPLIED WARRANTIES APPLICABLE TO THE PRODUCT INCLUDING, WITHOUT LIMITATION, ALL IMPLIED WARRANTIES OF MERCHANTABILITY AND FITNESS FOR USE ARE EXPRESSLY DISCLAIMED. The warranty information set forth above shall be governed by and construed in accordance with the laws of the State of North Carolina and, if applicable, the laws of the United States of America. The warranty, as stated, is extended only to the original owner/user and is not assignable. Serv-Ware reserves the right to change product specifications without notice due to constant product improvement.