

# Pizza Prep Table

Item # \_\_\_\_\_  
 Project : \_\_\_\_\_  
 Qty : \_\_\_\_\_

Model No.

**PP93-12-HC**

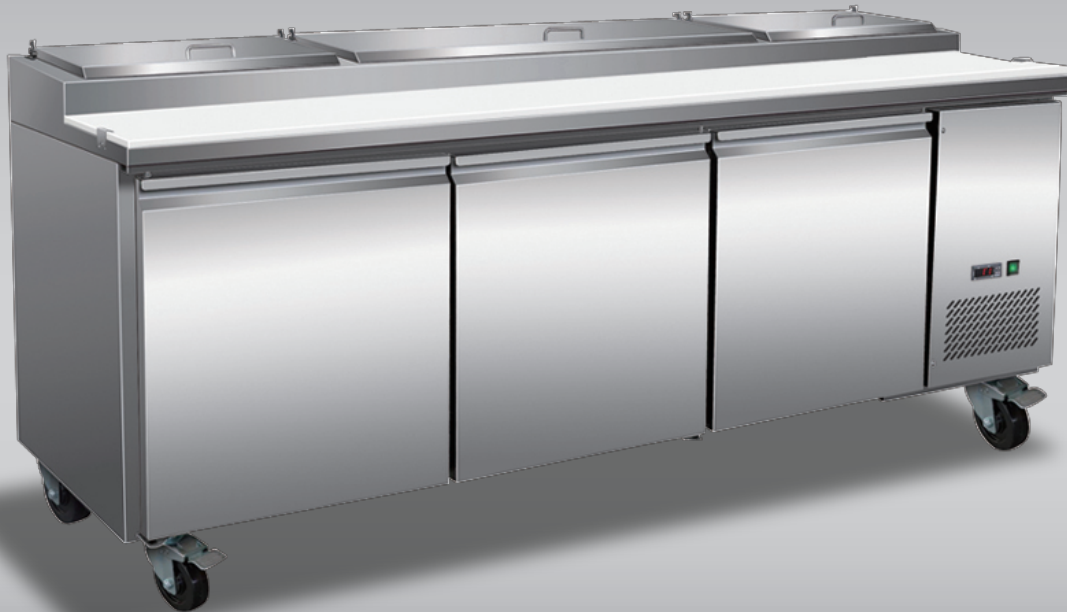

**PP93-12-HC**

## Features:

- CFC Free Refrigerant and Foam
- AISI 304 Stainless Steel Framework Construction
- Electronic Thermostat and Digital LED Temperature Display for Accurate Control and Easy Reading
- Auto Defrosting and Auto Evaporation of Condensation Water
- Magnetic Gaskets can be Replaced without any Tool
- PC Plastic Pans and Plastic Cutting Board are Included

## Warranty Info:

### Three Year

- Parts & Labor on entire unit.
- Valid in United States.
- Valid for commercial use only.

### Five Year

- Compressor, Part Only.



\* See last two pages for more information on warranties and additional extended warranty coverages.



Revised 03/25/2024

**PP93-12-HC**



www.servware.com

Phone:(800).768.5953

Fax:(800).976.1299

# PP93-12-HC Pizza Prep Table



Item # \_\_\_\_\_  
 Project : \_\_\_\_\_  
 Qty : \_\_\_\_\_

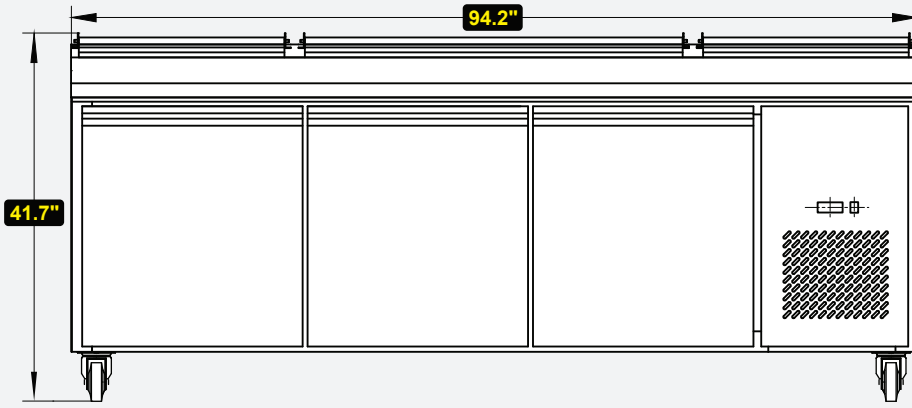

Front View

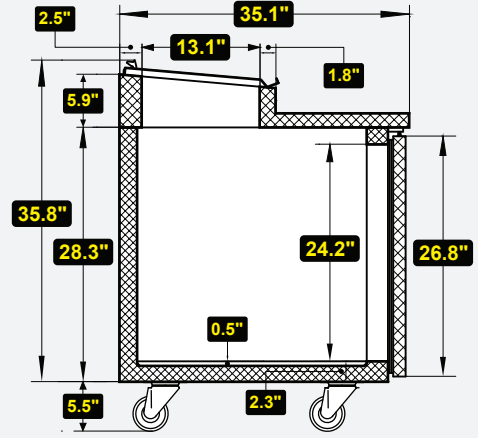

Side View

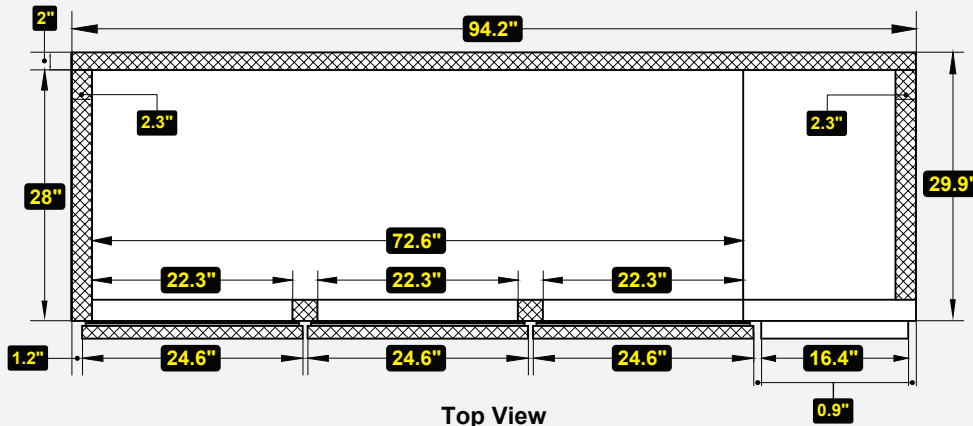

Top View



NEMA 5-15P

➤ Technical Information:

MODEL #	DESCRIPTION	DIMENSIONS ( W x D x H )	WEIGHT/LBS. (Shipping)
PP93-12-HC	12 Pan Prep Unit	94.2" W x 32.3" D x 41.3" H	575 lbs.

CONSTRUCTION	
Exterior Material	Stainless Steel
Interior Material	Painted Al. w/ 304 S/S Floor
Insulation Material	CFC Free Foam
Shelf Material	Epoxy Coated Wire
Number of Shelves	1 per Door

COOLING	
Temperature Range	33°F – 41°F
Refrigerant+Charge oz.	R290 / 3.7 oz.
BTU/H	1877
Defrosting	Every 6 Hours
Horse Power	¾
Storage Capacity	32 cu. ft.

ELECTRICAL	
Voltage	115
Amps	5.5
Hz	60
Phase	1

**ADDITIONAL INFORMATION**

*Installation by certified commercial restaurant equipment installer recommended. Inspection before and after installation by licensed electrician for safe operation. Product designed for interior usage in a climate controlled location with adequate air circulation and not adjacent to a high temperature source.*



Prop. 65 Warning for California Residents  
 WARNING: This product may contain chemicals known to the State of California to cause cancer, birth defects, or other reproductive harm.

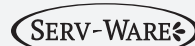

Copyright © 2024 Serv-Ware Products LLC.

Phone:(800).768.5953  
 Fax:(800).976.1299

www.servware.com

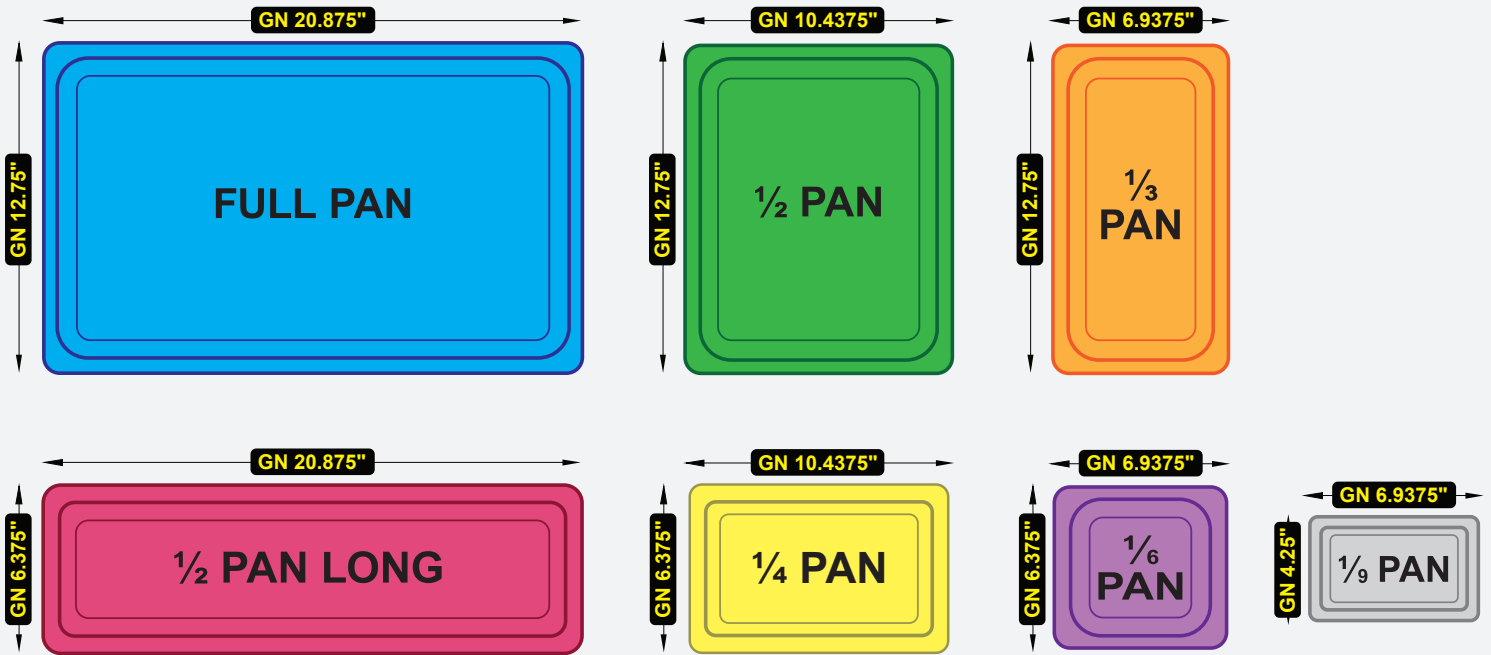

## Top View

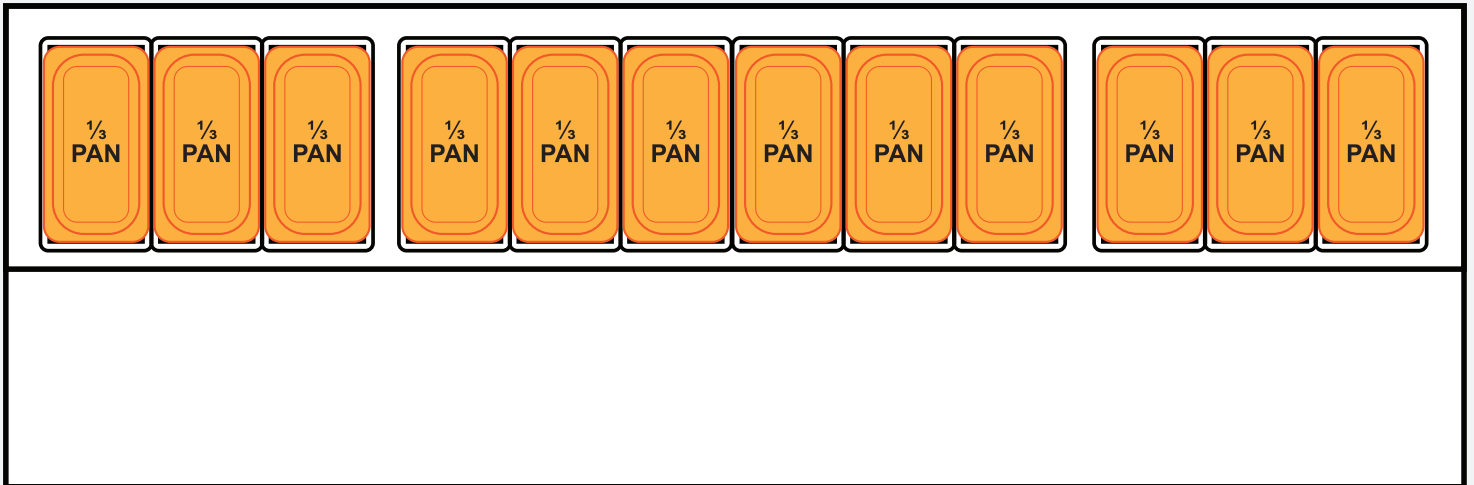

**GN 1/3 Pans - 12 Pieces**

## PP Series - Pizza Prep Refrigeration

**Notify carrier of damage! Inspect all components immediately.**

Serv-Ware Products warrants to the original owner/user that any Pizza Prep Table manufactured shall be free of defects in material or workmanship, under normal use and maintenance, for a period of three (3) years\* from the original installation date or a maximum of forty-two (42) months after the shipment date from Serv-Ware Products. **\*(Products purchased by the dealer before 06/09/22 will retain the original 2 year warranty)** Proper installation and start-up in accordance with the instruction manual supplied will be taken into consideration when evaluating the warranty on the specified equipment. Labor warranty charges are valid in the United States only.

The labor warranty shall include standard labor charges at the product location only. The end user is responsible for any emergency, overtime, or long-distance travel charges. Any labor service required to fulfill the warranty obligation must be performed by a refrigeration service company qualified and accepted by Serv-Ware Products. Billing will be handled between the service company and manufacturer directly, there will be no compensation for charges not billed to Serv-Ware Products by the service company. Serv-Ware Products reserves the right to have any warranty "failed" parts returned to the factory for inspection before agreeing to covering the above stated warranty labor charges.

### **This warranty does not include parts & labor coverage resulting from:**

- External electrical power failure or improper supply voltage to product.
- Adverse operating conditions for the product.
- Failure to clean the condenser coil and/or maintain the product.
- Standard wear & tear items such as gaskets, light bulbs, and door hinges.
- Damage that is caused by employees or customers.
- Any part or assembly that has been altered, modified, or changed.
- Equipment usage in a residential or non-commercial setting.

In addition to the three (3) year warranty stated above, Serv-Ware Products warrants its compressors to be free from defects in both material and workmanship, under normal use and maintenance, for a period of five (5) additional years from the date of original installation after shipment from Serv-Ware Products. The five (5) year compressor warranty applies only to the compressor part itself and does not apply to any other parts, components, or labor charges involved in replacement of compressor. The compressor failure must be verified by Serv-Ware Products via a qualified service technician at the end user's expense. Serv-Ware Products reserves the right to have the "failed" compressor returned to the factory for inspection before issuing a warranty compressor part only.

### **LIMITATION OF LIABILITY AND OTHER WARRANTIES**

Serv-Ware Products assumes no liability for misuse or inadequate maintenance of the Product. **In no event shall the user be entitled to recover incidental or consequential damages. Including but not limited to; damages for inconvenience, food loss, rental or replacement equipment, loss of profits, or other commercial loss.** Warranties stated above are the only warranties made in connection with the sale and distribution of the Products. **ANY AND ALL OTHER EXPRESSED STATUTORY AND IMPLIED WARRANTIES APPLICABLE TO THE PRODUCT INCLUDING, WITHOUT LIMITATION, ALL IMPLIED WARRANTIES OF MERCHANTABILITY AND FITNESS FOR USE ARE EXPRESSLY DISCLAIMED.** The warranty information set forth above shall be governed by and construed in accordance with the laws of the State of North Carolina and, if applicable, the laws of the United States of America. The warranty, as stated, is extended only to the original owner/user and is not assignable. Serv-Ware reserves the right to change product specifications without notice due to constant product improvement.

# Extended Warranty



## Extended Two-Year Terms & Conditions

*Notify carrier of damage! Inspect all components immediately.*

The conditions below describe the terms and scope of our two-year extended warranty.

*Please note that the purchase of the warranty for the extended warranty period is optional.*

- Starting March 18th, 2024 all refrigeration units that are listed can be purchased with an extended two-year warranty *\*(excluding chef base units)\**. This covers the standard parts and labor needed to repair the unit for an additional two years. Purchasing additional extended warranty only valid for units purchased on March 18th, 2024 and after. There will be no retro active extended warranty offer for any units purchased before March, 18th, 2024.
- It is optimal to purchase the extended warranty at the same time as the equipment to which it relates.
- Following our warranty statements, the extended warranty can be purchased up to six months after the original purchase with proof of sale to the end user in that allowed time frame.
- This extended warranty will follow our standard warranty guidelines.

*\*Chef base units have a one-year standard warranty, this is an option to purchase an additional four-year extended warranty\*.*

### LIMITATION OF LIABILITY AND OTHER WARRANTIES

*Serv-Ware Products assumes no liability for misuse or inadequate maintenance of the Product. In no event shall the user be entitled to recover incidental or consequential damages. Including but not limited to; damages for inconvenience, food loss, rental or replacement equipment, loss of profits, or other commercial loss. Warranties stated above are the only warranties made in connection with the sale and distribution of the Products. ANY AND ALL OTHER EXPRESSED STATUTORY AND IMPLIED WARRANTIES APPLICABLE TO THE PRODUCT INCLUDING, WITHOUT LIMITATION, ALL IMPLIED WARRANTIES OF MERCHANTABILITY AND FITNESS FOR USE ARE EXPRESSLY DISCLAIMED. The warranty information set forth above shall be governed by and construed in accordance with the laws of the State of North Carolina and, if applicable, the laws of the United States of America. The warranty, as stated, is extended only to the original owner/user and is not assignable. Serv-Ware reserves the right to change product specifications without notice due to constant product improvement.*



Phone: (800).768.5953  
Fax: (800).976.1299  
www.servware.com

Revised 03/15/2024

Copyright © 2024 Serv-Ware Products LLC.