

Table Sink

Model No.

TSF-3072-L



Features:

- 16 Gauge 304 stainless top shelf.
- 16 Gauge 304 stainless 1 left / right fabricated tub.
- 18 Gauge 430 stainless hat channel, stainless leg and socket, stainless bullet feet.
- Rounded edge / bullnose edge.
- Deck-mounted faucet DFY12-CWP, 4" centers, swing nozzle, 12" long spout (low lead) included.
- 3.5" drain basket included.

Warranty Info:

- See Last Pages



Revised 05/15/2020

TSF-3072-L



www.servware.com
 Phone:(800).768.5953
 Fax:(800).976.1299

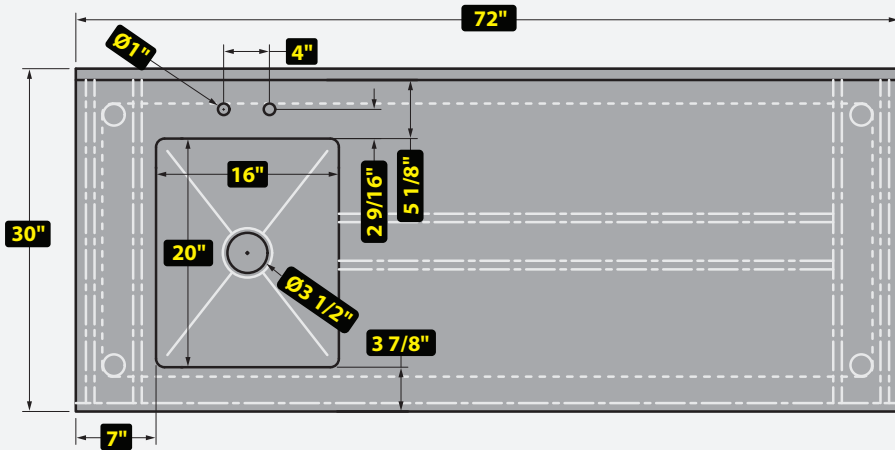

Top View

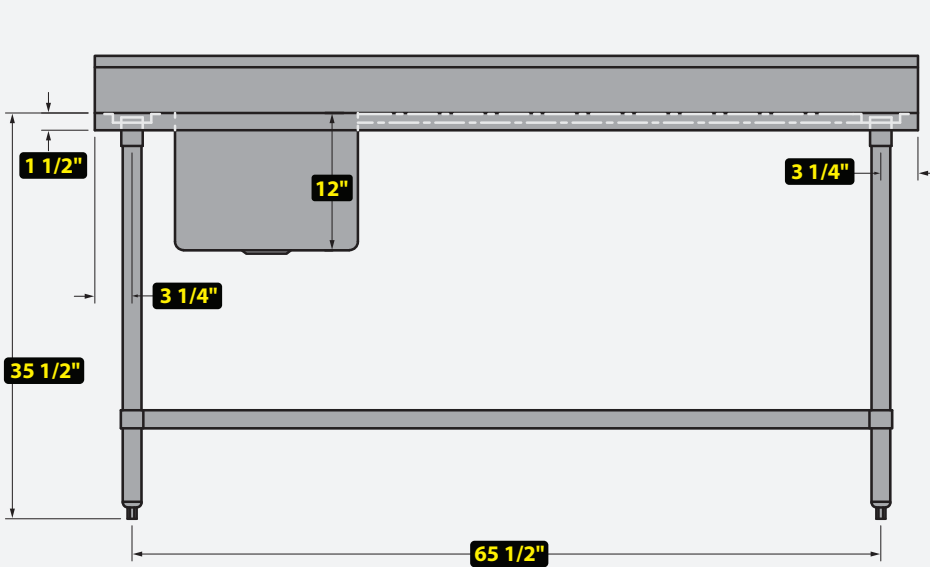

Front View

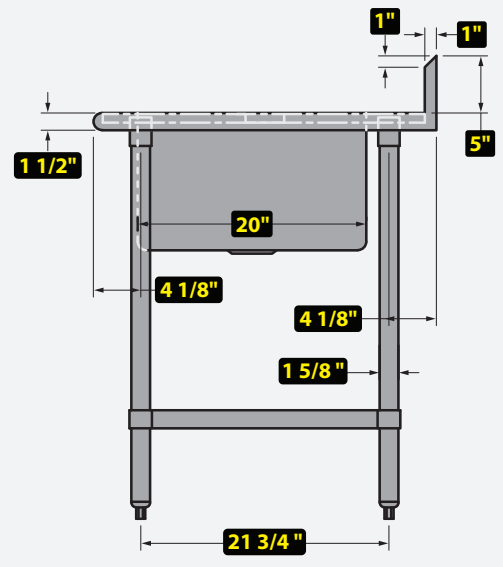

Side View

MODEL #	DESCRIPTION	DIMENSIONS (D x W x H)	WEIGHT/LBS. (Shipping)
TSF-3072-L	72" Table Sink	30" W x 72" D x 35.5" H	117 lbs.

# OF BOWLS	BOWL DIMENSIONS (W x D x H)	BACK SPLASH
1	16" W x 20" D x 12" H	5"

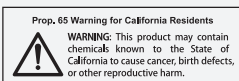

Phone:(800).768.5953
 Fax:(800).976.1299

All Serv-Ware Work Tables & Equipment Stands

Notify carrier of damage! Inspect all components immediately.

Serv-Ware Products warrants to the original owner/user that any product manufactured shall be free of defects in material or workmanship, under normal use and maintenance, for a period of one (1) year from the original installation date or a maximum of eighteen (18) months after the shipment date from Serv-Ware Products. Proper installation and start-up in accordance with the instruction manual supplied will be taken into consideration when evaluating the warranty on the specified equipment.

This warranty does not include labor charges. Serv-Ware Products reserves the right to have any warranty "failed" parts returned to the factory for inspection before agreeing to covering the above stated warranty.

This warranty does not include parts & labor coverage resulting from:

- Adverse operating conditions for the product.
- Failure to clean and/or maintain the product.
- Standard wear & tear items.
- Damage that is caused by employees or customers.
- Any part or assembly that has been altered, modified, or changed.
- Equipment usage in a residential or non-commercial setting.

LIMITATION OF LIABILITY AND OTHER WARRANTIES

Serv-Ware Products assumes no liability for misuse or inadequate maintenance of the Product. In no event shall the user be entitled to recover incidental or consequential damages. Including but not limited to; damages for inconvenience, food loss, rental or replacement equipment, loss of profits, or other commercial loss.

Warranties stated above are the only warranties made in connection with the sale and distribution of the Products. ANY AND ALL OTHER EXPRESSED STATUTORY AND IMPLIED WARRANTIES APPLICABLE TO THE PRODUCT INCLUDING, WITHOUT LIMITATION, ALL IMPLIED WARRANTIES OF MERCHANTABILITY AND FITNESS FOR USE ARE EXPRESSLY DISCLAIMED. The warranty information set forth above shall be governed by and construed in accordance with the laws of the State of North Carolina and, if applicable, the laws of the United States of America. The warranty, as stated, is extended only to the original owner/user and is not assignable. Serv-Ware reserves the right to change product specifications without notice due to constant product improvement.

All Serv-Ware Sinks

Notify carrier of damage! Inspect all components immediately.

Serv-Ware Products warrants to the original owner/user that any product manufactured shall be free of defects in material or workmanship, under normal use and maintenance, for a period of one (1) year from the original installation date or a maximum of eighteen (18) months after the shipment date from Serv-Ware Products. Proper installation and start-up in accordance with the instruction manual supplied will be taken into consideration when evaluating the warranty on the specified equipment.

This warranty does not include labor charges. Serv-Ware Products reserves the right to have any warranty "failed" parts returned to the factory for inspection before agreeing to covering the above stated warranty.

This warranty does not include parts & labor coverage resulting from:

- Adverse operating conditions for the product.
- Failure to clean and/or maintain the product.
- Standard wear & tear items.
- Damage that is caused by employees or customers.
- Any part or assembly that has been altered, modified, or changed.
- Equipment usage in a residential or non-commercial setting.

LIMITATION OF LIABILITY AND OTHER WARRANTIES

Serv-Ware Products assumes no liability for misuse or inadequate maintenance of the Product. In no event shall the user be entitled to recover incidental or consequential damages. Including but not limited to; damages for inconvenience, food loss, rental or replacement equipment, loss of profits, or other commercial loss.

Warranties stated above are the only warranties made in connection with the sale and distribution of the Products. ANY AND ALL OTHER EXPRESSED STATUTORY AND IMPLIED WARRANTIES APPLICABLE TO THE PRODUCT INCLUDING, WITHOUT LIMITATION, ALL IMPLIED WARRANTIES OF MERCHANTABILITY AND FITNESS FOR USE ARE EXPRESSLY DISCLAIMED. The warranty information set forth above shall be governed by and construed in accordance with the laws of the State of North Carolina and, if applicable, the laws of the United States of America. The warranty, as stated, is extended only to the original owner/user and is not assignable. Serv-Ware reserves the right to change product specifications without notice due to constant product improvement.

All Serv-Ware Faucets

Notify carrier of damage! Inspect all components immediately.

Serv-Ware Products warrants to the original owner/user that any product manufactured shall be free of defects in material or workmanship, under normal use and maintenance, for a period of one (1) year from the original installation date or a maximum of eighteen (18) months after the shipment date from Serv-Ware Products. Proper installation and start-up in accordance with the instruction manual supplied will be taken into consideration when evaluating the warranty on the specified equipment.

This warranty does not include labor charges. Serv-Ware Products reserves the right to have any warranty "failed" parts returned to the factory for inspection before agreeing to covering the above stated warranty.

This warranty does not include parts & labor coverage resulting from:

- Adverse operating conditions for the product.
- Failure to clean and/or maintain the product.
- Standard wear & tear items.
- Damage that is caused by employees or customers.
- Any part or assembly that has been altered, modified, or changed.
- Equipment usage in a residential or non-commercial setting.

LIMITATION OF LIABILITY AND OTHER WARRANTIES

Serv-Ware Products assumes no liability for misuse or inadequate maintenance of the Product. In no event shall the user be entitled to recover incidental or consequential damages. Including but not limited to; damages for inconvenience, food loss, rental or replacement equipment, loss of profits, or other commercial loss.

Warranties stated above are the only warranties made in connection with the sale and distribution of the Products. ANY AND ALL OTHER EXPRESSED STATUTORY AND IMPLIED WARRANTIES APPLICABLE TO THE PRODUCT INCLUDING, WITHOUT LIMITATION, ALL IMPLIED WARRANTIES OF MERCHANTABILITY AND FITNESS FOR USE ARE EXPRESSLY DISCLAIMED. The warranty information set forth above shall be governed by and construed in accordance with the laws of the State of North Carolina and, if applicable, the laws of the United States of America. The warranty, as stated, is extended only to the original owner/user and is not assignable. Serv-Ware reserves the right to change product specifications without notice due to constant product improvement.