



FOR QUESTIONS, CONTACT THE
SERVICE DEPARTMENT AT:
service@servware.com or
800-768-5953

Undercounter Refrigerator and Freezer

Service, Installation and Care Manual

Please read this manual completely before attempting to install or operate this equipment.
Notify carrier of damage! Inspect all components immediately.



**IMPORTANT INFORMATION
ABOUT YOUR SERV-WARE™ UNIT ENCLOSED.
PLEASE READ BEFORE USE!**

Save These Instructions!

Parts & Service Manuals Available at:
www.servware.com

800-768-5953

COMMERCIAL REFRIGERATOR SAFETY

Your safety and the safety of others are very important.

We have provided many important safety messages in this manual and on your appliance. Always read and obey all safety messages.



This is the Safety Alert Symbol. This symbol alerts you to potential hazards that can kill or injure you and others. All safety messages will follow the Safety Alert Symbol and either the words "**DANGER**", "**WARNING**" or "**CAUTION**".



DANGER means that failure to heed this safety statement may result in severe personal injury or death.



WARNING means that failure to heed this safety statement may result in extensive product damage, serious personal injury, or death.



CAUTION means that failure to heed this safety statement may result in minor or moderate personal injury, or property or equipment damage.

All safety messages will alert you to what the potential hazard is, tell you how to reduce the chance of injury, and let you know what can happen if the instructions are not followed.

If the supply cord is damaged, it must be replaced by the manufacturer, its service agent or similarly qualified persons in order to avoid a hazard. This appliance is not intended for use by persons with lack of experience and knowledge regarding this type of equipment, unless they have been given supervision or instruction concerning use of the appliance by a person responsible for their safety. Cleaning and user maintenance shall not be made by inexperienced persons without supervision.

Do not store explosive substances such as aerosol cans with a flammable propellant in this appliance. The appliance uses flammable insulation blowing gas C5H10, disposal of the appliance shall be in accordance with the regulations of federal, state and local authorities.

COMMERCIAL REFRIGERATOR SAFETY

The key for appliance electric box should be safe kept by qualified persons in order to avoid a hazard.



WARNING: Risk of fire / flammable materials.

WARNING: Keep ventilation openings, in the appliance enclosure or in the built-in structure, clear of obstruction.

WARNING: Do not use mechanical devices or other means to accelerate the defrosting process, other than those recommended by the manufacturer.

WARNING: Do not damage the refrigerant circuit.

WARNING: Do not use electrical appliances inside the food storage compartments of the appliance, unless they are of the type recommended by the manufacturer. Handling, moving, and use of the refrigerator or freezer to avoid either damaging the refrigerant tubing, or increasing the risk of a leak.

L'opération, le mouvement et l'utilisation du réfrigérant ou le congélateur doivent éviter les dommages du tuyau réfrigérant ou le risque de la fuite.

CAUTION: Risk of Fire or Explosion due to Flammable Refrigerant Used. Follow Handling Instructions Carefully in Compliance with U.S. Government Regulations. Component parts shall be replaced with like components and that servicing shall be done by factory authorized service personnel, so as to minimize the risk of possible ignition due to incorrect parts or improper service.

Les pièces de rechange doivent être remplacées par les composants relatifs et les opérations doivent être faites par les professionnels afin de minimaliser le risque d'allumage à cause des parts incorrects ou des opérations impropres.

CAUTION: Risk Of Fire Or Explosion Due To Puncture Of Refrigerant Tubing; Follow Handling Instructions Carefully. Flammable Refrigerant Used.

DANGER: Risk of child entrapment. Before you throw away your old refrigerator or freezer:

- Take off the doors
- Leave the shelves in place so that children may not easily climb inside

CONTENTS

RECEIVING & INSPECTING EQUIPMENT.....	3
SPECIFICATIONS.....	4
INSTALLATION.....	5
OPERATION.....	6
MAINTENANCE.....	8
WIRING DIAGRAM.....	11

© Copyright 2019 Ser-Ware Products Incorporated. All rights reserved.
Reproduction without written permission is prohibited.

SERIAL NUMBER INFORMATION

The serial number of all self-contained refrigerators and freezers is located inside the unit on the left hand side near the top on the wall.

Always have the serial number of your unit available when calling for parts or service.

This manual covers standard units only. If you have a custom unit, consult the customer service department at the number listed on the last page.

RECEIVING AND INSPECTING THE EQUIPMENT

Even though most equipment is shipped crated, care should be taken during unloading so the equipment is not damaged while being moved into the building.

1. Visually inspect the exterior of the package and skid or container. Any damage should be noted and reported to the delivering carrier immediately.
2. If damaged, open and inspect the contents with the carrier.
3. In the event that the exterior is not damaged, yet upon opening, there is concealed damage to the equipment, notify the carrier. Notification should be made verbally as well as in written form.
4. Request an inspection by the shipping company of the damaged equipment. This should be done within 10 days from receipt of the equipment.
5. Be certain to check the compressor compartment housing and visually inspect the refrigeration package. Be sure lines are secure and base is still intact.
6. Freight carriers can supply the necessary damage forms upon request.
7. Retain all crating material until an inspection has been made or waived.

SPECIFICATION

MODEL #	V/Hz/Ph	AMPS	STORAGE CAPACITY Cu-ft	HP	BTU/H	CHARGE OZ	SHIP WEIGHT LBS	NEMA PLUG
ER5-HC	115/60/1	2	5	1/8	409	1.23	109	5-15P
EF5-HC	115/60/1	2	5	1/5	852	2.25	108	5-15P

INSTALLATION

Location:

Units represented in this manual are intended for indoor use only. Be sure the location chosen has a floor strong enough to support the total weight of the cabinet and contents. A fully loaded unit can weigh as much as 1500 pounds. Reinforce the floor as necessary to provide for maximum loading. For the most efficient refrigeration, be sure to provide good air circulation inside and out.

Inside cabinet:

Do not pack the units so full that air cannot circulate. The refrigerated air is discharged at the top rear of the unit. It is important to allow for proper air flow from the top rear to the bottom of the unit. Obstructions to this air flow can cause evaporator coil freeze ups and loss of temperature or overflow of water from the evaporator drain pan. The shelves have a rear turn up on them to prevent this. However, bags and other items can still be located to the far rear of the cabinet. Air is brought into the evaporator coil with fans mounted to the front of the coil.

Outside cabinet:

Be sure that the unit has access to ample air. Avoid hot corners and locations near stoves and ovens. It is recommended that the unit be installed no closer than 2" from any wall with at least 12" of clear space above the unit.

Leveling:

A level cabinet looks better and will perform better because the doors will line up with the frames properly. Use a level to make sure the unit is level from front to back and side to side. Units supplied with legs will have adjustable bullet feet to make the necessary adjustments. If the unit is supplied with casters, no adjustments are available. Ensure the floor where the unit is to be located is level.

Stabilizing:

All models are supplied with casters for your convenience, ease of cleaning underneath and for mobility. It is very important, however, that the cabinet be installed in a stable condition with the front wheels locked while in use.

Should it become necessary to lay the unit on its side or back for any reason, allow at least 24 hours before start-up to allow compressor oil to flow back into place. Failure to meet this requirement can cause compressor failure and unit damage.



NOTE!

Unit repairs will not be subject to standard unit warranties if due to improper installation procedures.

Electrical connection:

Refer to the amperage data on page 3, the serial tag, your local code or the National Electrical Code to be sure the unit is connected to the proper power source.



DANGER!

The unit must be turned OFF and disconnected from the power source whenever performing service, maintenance functions or cleaning the refrigerated area.

OPERATION**CAUTION!**

Do not throw items into the storage area. Failure to heed these recommendations could result in damage to the interior of the cabinet.

REFRIGERATED CYCLE**Refrigerators:**

During the refrigeration cycle, the evaporator fans will run continuously even when one or more doors are open. The door switch will activate the lights when opened.

1. Every 6 hours, the unit will turn off and to allow the evaporator coil to defrost. The controller now displays the defrost symbol. When the coil temperature reaches 41°F or after 20 minutes of defrost, the unit will turn on again.
2. Anti-condensation heaters on door frames work in conjunction with the compressor.
3. The factory setting for the temperature range is 34 to 38° F.

Freezers:

During the refrigeration cycle the controller supplies power to the condensing unit and evaporator fan motors. The evaporator fans will run at any time when the evaporator coil temperature is below 54° F, they will also keep running during when door is open but cycle off during a defrost period. The door switch will activate the lights when opened.

1. Every 6 hours, the unit will turn off and electric heater will turn on to start the defrost cycle. The controller now displays the defrost symbol. When the coil temperature reaches 45°F or after 20 minutes of defrost, the unit will turn on again.
2. Anti-condensation heaters on door frames work in conjunction with the compressor.
3. The factory setting for the temperature range is -7 to -1°F.

SOLID-STATE THERMOSTAT DESCRIPTIONS**1. FRONT PANEL COMMANDS****SET**

To display target set point; in programming mode it selects a parameter or confirms an operation.



To start a manual defrost.



To view the latest alarm occurrence; in programming mode it browses the parameter codes or increases the display value.



To view the latest alarm occurrence; in programming mode it browses the parameter codes or increases the display value.

KEY COMBINATIONS

To lock & unlock the keyboard.











To enter in programming mode.



To return to the room temperature display.

OPERATION

1. 1 FUNCTION OF LEDS

LED	MODE	FUNCTION
	ON	Compressor Enabled
	FLASHING	Programming Phase (Flashing with ) Anti-short Cycle Delay Enabled
	ON	Defrost Enabled
	FLASHING	Programming Phase (Flashing with ) Drip Time in Progress
	ON	Fans Enabled
	FLASHING	Fans Delay after Defrost in Progress
	ON	A Temperature Alarm happened



2. MAIN FUNCTIONS

2.1 HOW TO SEE THE SETPOINT

1. Push and immediately release the **SET** key: the display will show the set point value.
2. Push and immediately release the **SET** key or wait for 5 seconds to display the sensor value again.



2.2 HOW TO CHANGE THE SETPOINT

1. Hold the **SET** key for more than 2 seconds to change the set point value.
2. The value of the set point will be displayed and the  LED starts blinking.
3. To change the set value push the  or  key within 10s.
4. To set a new point value, push the **SET** key again or wait 10s.





2.3 HOW TO START A MANUAL DEFFROST

Hold the  key for more than 2 seconds and the manual defrost will start.





2.4 HOW TO LOCK THE KEYBOARD

1. Hold the  and  keys for more than 3s.
2. The “POF” message will be displayed and the keyboard will be locked. At this point, it will be possible only to see the set point or the MAX or Min temperature stored.
3. If a key is pressed more than 3s the ”POF” message will be displayed.



2.5 HOW TO UNLOCK THE KEYBOARD



Hold the  and  keys together for more than 3s, till the “POF” message is displayed.



OPERATION

3. ALARM SIGNALS

HOW TO SEE THE ALARM AND RESET THE RECORDED ALARM

1. Hold the  or  key to display the alarm signals.
2. When the signal is displayed, hold the **SET** key until the “rst” message is displayed, and push the **SET** key again. The “rst” message starts blinking and the normal temperature will be displayed.

MESSAGE	CAUSE	OUTPUTS
“P1”	Room Probe Failure.	Compressor Output according to Par, “CON” & “COF”.
“P2”	Evaporator Probe Failure.	Defrost End is timed.
“HA”	Maximum Temperature Alarm.	Outputs unchanged.
“LA”	Minimum Temperature Alarm.	Outputs unchanged.
“DA”	Door Open.	Compressor & Fans restart.
“EA”	External Alarm.	Outputs unchanged.
“CA”	Serious External Alarm (iF=BAL).	All Outputs OFF.
“CA”	Pressure Switch Alarm (iF=PAL).	All Outputs OFF.

MAINTENANCE



The unit must be turned OFF and disconnected from the power source whenever performing service, maintenance functions or cleaning the refrigerated area.

Refrigerators and Freezers:

The interior and exterior can be cleaned using soap and warm water. If this isn't sufficient, try ammonia and water or a nonabrasive liquid cleaner. When cleaning the exterior, always rub with the “grain” of the stainless steel to avoid marring the finish.

Do not use an abrasive cleaner because it will scratch the stainless steel and plastic and can damage the breaker strips and gaskets.

MAINTENANCE

Cleaning the Condenser Coil:

The condenser coil requires regular cleaning, and is recommended every 90 days. In some instances, you may find that there is a large amount of debris and dust or grease accumulated prior to the 90 day time frame. In these cases the condenser coil should be cleaned every 30 days.

If the build up on the coil consists of only light dust and debris, the condenser coil can be cleaned with a simple brush. Heavier dust build-up may require a vacuum or even compressed air to blow through the condenser coil.

If heavy grease is present, there are de-greasing agents available for refrigeration use and specifically for the condenser coils. The condenser coil may require cleaning with the de-greasing agent and then blown through with compressed air.

Failure to maintain a clean condenser coil can initially cause high temperatures and excessive run times. Continuous operation with dirty or clogged condenser coils can result in compressor failures. Neglecting the condenser coil cleaning procedures will void any warranties associated with the compressor or cost to replace the compressor.

DANGER!



Never use a high pressure water wash for this cleaning procedure as water can damage the electrical components located near or at the condenser coil.

In order to maintain proper refrigeration performance, the condenser fins must be cleaned of dust, dirt and grease regularly. It is recommended that this be done at least every three months. If conditions are such that the condenser is totally blocked in three months, the frequency of cleaning should be increased. Clean the condenser with a vacuum cleaner or stiff brush. If extremely dirty, a commercial-grade condenser cleaner may be required.

Stainless Steel Care and Cleaning:

To prevent discoloration of rust on stainless steel, several important steps need to be taken. First, we need to understand the properties of stainless steel. Stainless steel contains 70-80% iron which will rust. It also contains 12-30% chromium which forms an invisible passive film over the steels surface which acts as a shield against corrosion. As long as the protective layer is intact, the metal is still stainless. If the film is broken or contaminated, outside elements can begin to breakdown the steel and begin to form rust or discoloration.

Proper cleaning of stainless steel requires soft cloths or plastic scouring pads.

DANGER!



NEVER USE STEEL PADS, WIRE BRUSHES OR SCRAPERS!

MAINTENANCE

Cleaning solutions need to be alkaline based or non-chloride based. Any cleaner containing chlorides will damage the protective film of the stainless steel. Chlorides are also commonly found in hard water, salts, and household and industrial cleaners. If cleaners containing chlorides are used, be sure to rinse and dry thoroughly.

Routine cleaning of stainless steel can be done with soap and water. Extreme stains or grease should be cleaned with a non-abrasive cleaner and plastic scrub pad. It is always good to rub with the grain of the steel. There are also stainless steel cleaners available which can restore and preserve the finish of the steels protective layer.

Early signs of stainless steel breakdown can consist of small pits and cracks. If this has begun, clean thoroughly and start to apply stainless steel cleaners in attempt to restore the passivity of the steel.



CAUTION!

Never use an acid based cleaning solution! Many food products have an acidic content which can deteriorate the finish. Be sure to clean the stainless steel surfaces of ALL food products.

Gasket Maintenance:

Gaskets require regular cleaning to prevent mold and mildew build up and also to keep the elasticity of the gasket. Gasket cleaning can be done with the use of warm soapy water. Avoid full strength cleaning products on gaskets as this can cause them to become brittle and prevent proper seals. Do not use sharp tools or knives to scrape or clean the gasket which could possibly tear the gasket and rip the bellows.

Gaskets can easily be replaced and don't require the use of tools or authorized service technicians. The gaskets are "Dart" style and can be pulled out of the grove in the door and replaced by pressing the new one back into place.

Doors/Hinges:

Over time and with heavy use, door hinges may become loose. If the door is beginning to sag, tighten the screws that mount the hinge brackets to the frame of the unit. If the doors are loose or sagging, this can cause the hinge to pull out of the frame which may damage both the doors and the door hinges.

Drain Maintenance:

Each unit has a drain located inside the unit which removes the condensation from the evaporator coil and evaporates it into an external condensate evaporator pan. Each drain can become loose or disconnected from moving or bumping the drain. If you notice excessive water accumulation on the inside of the unit, be sure the drain tube is connected from the evaporator housing to the condensate evaporator drain pan. If water starts to collect underneath the unit, you may want to check the condensate evaporator drain tube to be sure it is still located inside the drain pan. The leveling of the unit is important as the units are designed to drain properly when on a level surface. If your floor is not level this can also cause drain problems. Be sure all drain lines are free of obstructions because this can cause water to back up and overflow the drain pans.

WIRING DIAGRAM

MODEL: ER5-HC

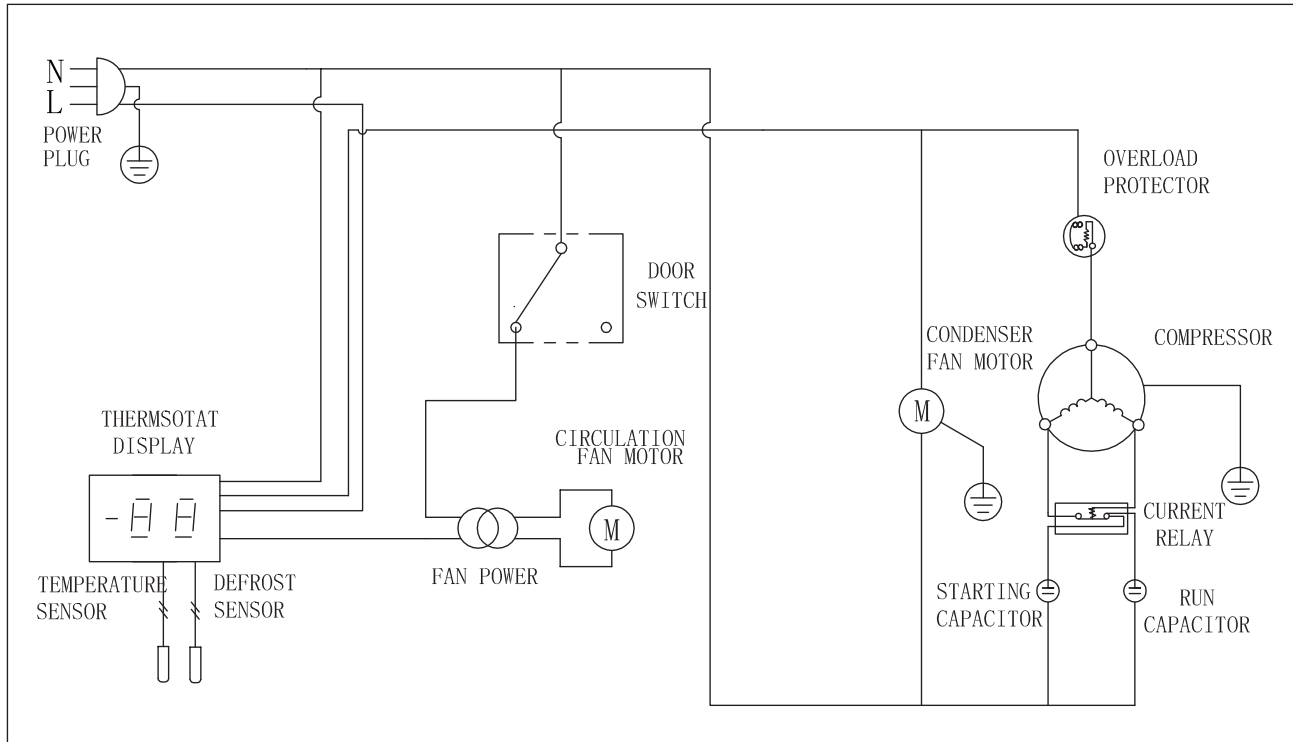

MODEL: EF5-HC

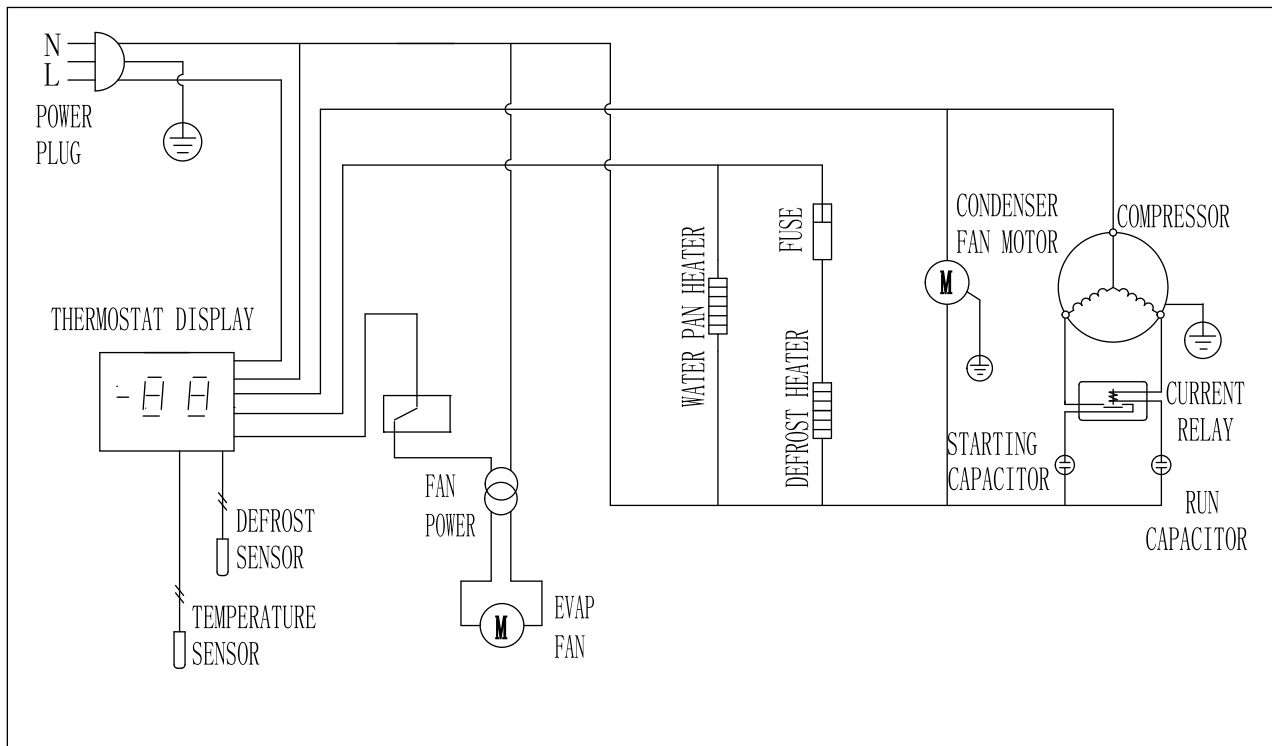

WIRING DIAGRAM

**MODEL:
ER5-HC**

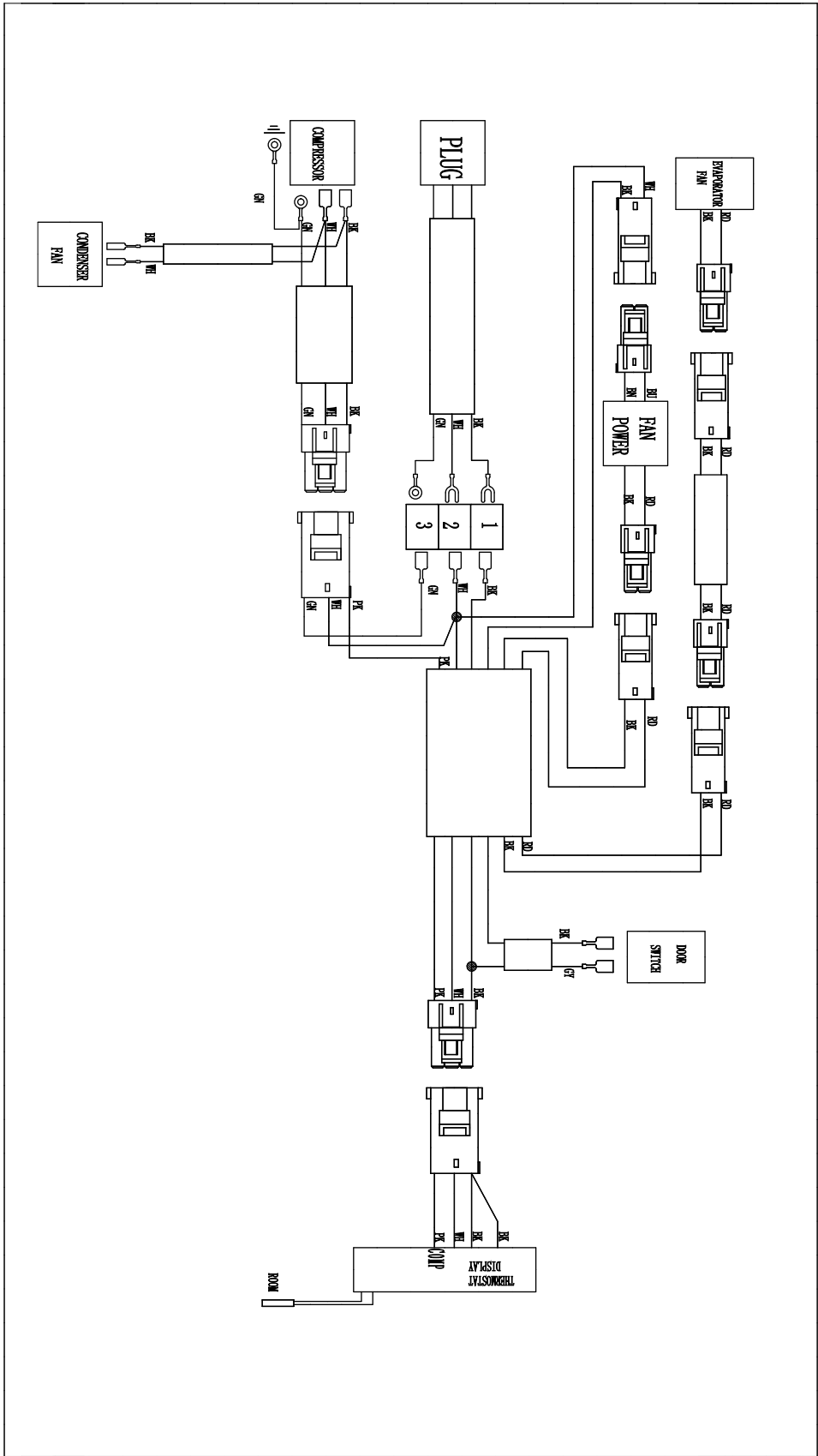

WIRING DIAGRAM

MODEL:
EF5-HC

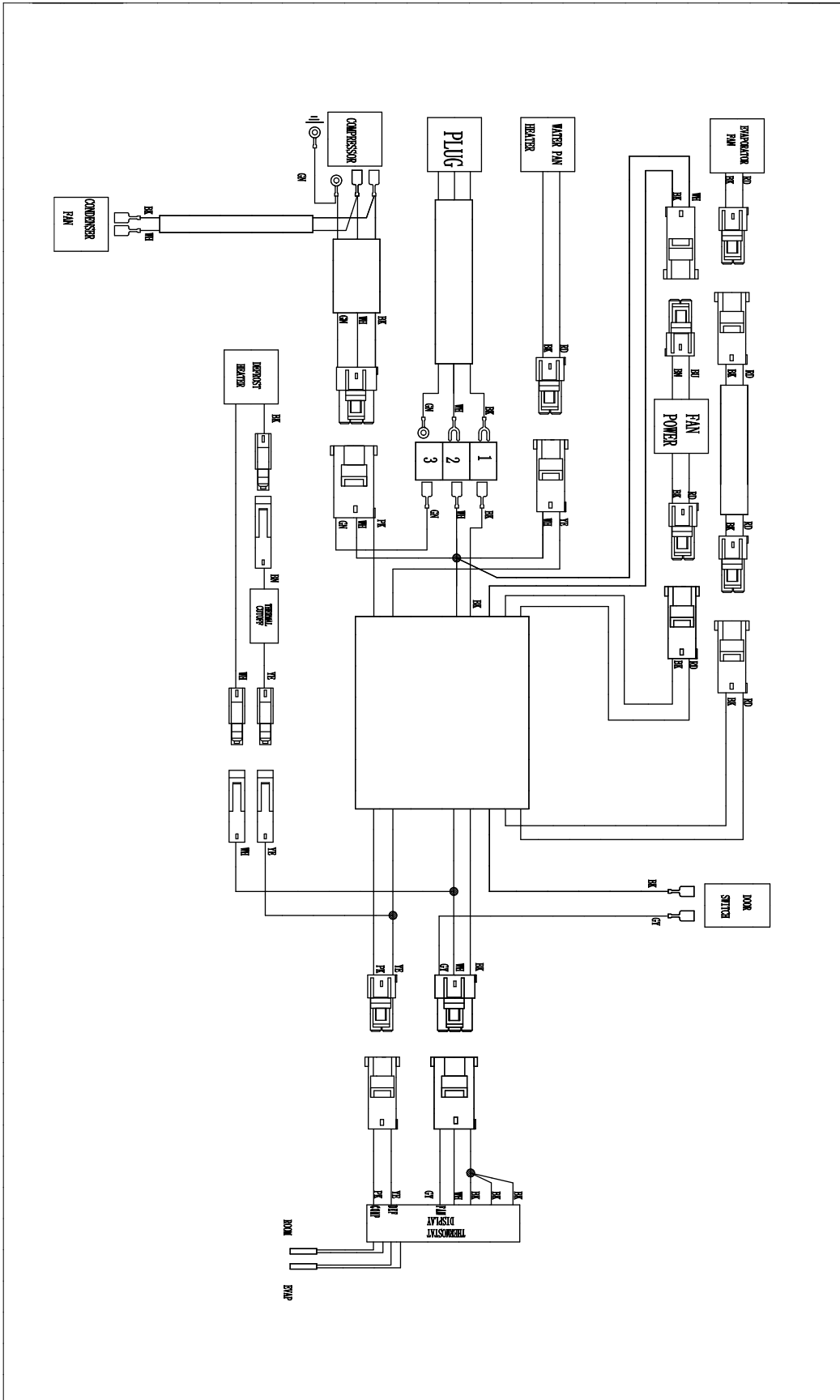

SERV-WARE PRODUCTS LIMITED LABOR AND PARTS WARRANTY REFRIGERATORS AND FREEZERS

Serv-Ware Products warrants to the original owner/user that any Refrigerator or Freezer manufactured by Serv-Ware Products (“the products”) shall be free of defects in material or workmanship under normal and proper use and maintenance service as specified by Serv-Ware Products and upon proper installation (not to exceed 120 days from date of original shipment) and start-up in accordance with the instruction manual supplied with the Product. ***The obligation of Serv-Ware Products and the rights and remedies of the owner/ user under this warranty are exclusively limited to (1) the repair or replacement, including labor charges, of parts or assemblies that in Serv-Ware Products opinion are defective within one year after the original date of installation;*** The labor warranty shall include standard straight time labor charges at the product location only and shall exclude charges for travel time, mileage or other premium charges. Any labor service required to fulfill the warranty obligation must be performed by a refrigeration service company qualified and accepted by Serv-Ware Products.

(See Specification sheets for warranty period details.)

This warranty does not include parts or labor coverage for component failure or other damage resulting from:

- External electrical power failure or miswiring to Product for any reason.
- Adverse operating conditions as set forth in the owner/user manual for the Product.
- Failure to clean and/or maintain Product as set forth in the owner/ user manual for the Product.

All claims for labor or parts must be made through Serv-Ware Products. The defective part for which labor reimbursement is claimed, together with the service invoice, must be returned to the Serv-Ware Products within fifteen days from the date of service to be eligible for labor and parts warranty coverage. All replacement parts must be approved Serv-Ware Products parts. Incidents of failure that do not require replacement of a part shall be explained in sufficient detail on the service invoice to identify the failure. All claims shall include the product model number, serial number, original date of installation and customer identification.

The foregoing warranty shall not apply to (1) any part or assembly (a) that has been altered, modified, or changed, (b) that has been subjected to misuse, abuse, neglect or accidents, or (c) any Product on which the serial or model number has been removed or altered, or (2) any Product that has been installed and /or maintained inconsistent with Serv-Ware Product’s technical publications, or (3) any Product that has been installed or is located outside the standard warranty coverage area. Warranty valid in United States only. Contact factory for warranty in other countries.

“LIMITATION OF LIABILITY AND OTHER WARRANTIES”

Serv-Ware Products assumes no liability for misuse or inadequate maintenance of the Product. **In no event shall the user be entitled to recover incidental or consequential damages, including but not limited to, damages for inconvenience, food loss, rental or replacement equipment, loss of profits, or other commercial loss.** Warranties stated above are the only warranties made in connection with the sale and distribution of the Products. ANY AND ALL OTHER EXPRESSED, STATUTORY AND IMPLIED WARRANTIES APPLICABLE TO THE PRODUCT INCLUDING, WITHOUT LIMITATION, ALL IMPLIED WARRANTIES OF MERCHANTABILITY AND FITNESS FOR USE ARE EXPRESSLY DISCLAIMED. The warranty information set forth above shall be governed by and construed in accordance with the laws of the State of North Carolina and, if applicable, the laws of the United States of America. The warranty, as stated, is extended only to the original owner/user and is not assignable.

NOTES

Lined area for notes, consisting of 28 horizontal lines.



SERV-WARETM Products Inc.

222 Hwy 58 South
Kinston, NC 28504

Parts & Service Manuals Available at:

www.servware.com

800•768•5953

Prop. 65 Warning for California Residents



WARNING: This product may contain chemicals known to the State of California to cause cancer, birth defects, or other reproductive harm.