

2025 SERV-WARE™

PRODUCT CATALOG
UPDATED

Call Toll Free
800.768.5953

Fax Toll Free
800.976.1299

Please Email Purchase Orders
to: sw-info@servware.com

NEW Products!



 Global Warranty

www.servware.com



Our mission here at SERV-WARE™ is to provide the highest quality products for our pricing level in the food service industry.

The Serv-Ware Difference

When choosing a company for your specific food service requirements, you need a company that's experienced, responsive and can deliver in more ways than one. That's why at the very heart of Serv-Ware is our team. Our team is experienced in all facets of the food service equipment industry and we are always here to support our customer network no matter how big or small the project.

Your #1 Source

From refrigerators and freezers, sandwich and pizza preps, glass door merchandise, cooking equipment, wire shelving, sinks and tables to worktables and stands to plumbing, think Serv-Ware Products. And when you need customer service that's above and beyond, call on the Serv-Ware team, we'll be there to fulfill your needs!

"The company that strives to find new ways to give more for a buck than take more for a buck will surely do well and shake their industry."

- Henry Ford



SERV-WARE™

Corporate Office
222 Hwy 58 South
Kinston, NC 28504
157,000 Square foot warehouse

Houston, Texas

Visit our website at www.servware.com

Se habla español



Refrigeration

**NEW
Products!**

Page 1-12



Cooking Equipment

**NEW
Products!**

Page 13-29



Food Processing Equipment

Page 30

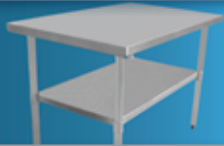

Tables & Stands

**NEW
Products!**

Page 31-34



Sinks & Accessories

Page 35-44



Plumbing

Page 45-48

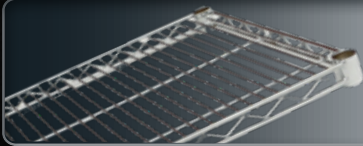

Wire Shelving

Page 49-54



Aluminum Racks

Page 55



Casters & Inserts

Page 56



Janitorial

Page 57

Stainless Steel Reach-In Refrigerators

Features & Benefits:

- Electronic thermostat and digital LED temperature display
- High efficiency CFC free insulation
- Stainless steel front and sides (except glass door)
- Self-closing doors with full length handle, remain open past 90°
- 3 shelves per door
- EXTERIOR: Stainless Steel
- INTERIOR: Stainless steel
- Shipped with casters not installed
- 3 year parts & labor warranty. 5 year compressor part warranty.

One Door Refrigerators



Item #	Description	Size	Price Ea.
● RR1-19-HC**	1 Door 19 cu. ft. Refrigerator	25.6" W x 25.6" D x 82.3" H	\$
● RR1-HC**	1 Door 23 cu. ft. Refrigerator	27" W x 33" D x 82.3" H	\$

Two Door Refrigerators

Item #	Description	Size	Price Ea.
● RR2-35-HC	2 Door 35 cu. ft. Refrigerator	39.5" W x 32.7" D x 82.3" H	\$
● RR2-HC**	2 Door 49 cu. ft. Refrigerator	54" W x 33" D x 82.3" H	\$

Three Door Refrigerator

Item #	Description	Size	Price Ea.
● RR3-HC**	3 Door 72 cu. ft. Refrigerator	81" W x 33" D x 82.3" H	\$



Stainless Steel Reach-In Freezers

Features & Benefits:

- Electronic thermostat and digital LED temperature display
- High efficiency CFC free insulation
- Stainless steel front and sides (except glass door)
- Self-closing doors with full length handle, remain open past 90°
- 3 shelves per door
- EXTERIOR: Stainless Steel
- INTERIOR: Stainless steel
- Shipped with casters not installed
- 3 year parts & labor warranty. 5 year compressor part warranty.



One Door Freezers



Item #	Description	Size	Price Ea.
● RF1-19-HC**	1 Door 19 cu. ft. Freezer	26.8" W x 25.6" D x 82.3" H	\$
● RF1-HC**	1 Door 23 cu. ft. Freezer	27" W x 33" D x 82.3" H	\$

Two Door Freezers

Item #	Description	Size	Price Ea.
RF2-35-HC	2 Door 35 cu. ft. Freezer	35.5" W x 32.7" D x 82.3" H	\$
● RF2-HC**	2 Door 49 cu. ft. Freezer	54" W x 33" D x 82.3" H	\$



Three Door Freezer

Item #	Description	Size	Price Ea.
● RF3-HC**	3 Door 72 cu. ft. Freezer	81" W x 33" D x 82.3" H	\$

* Single Phase 220 - 240 volts.



Glass Door Reach-In Refrigerators - Stainless Steel

Features & Benefits:

- R²⁹⁰ HC refrigerant
- Electronic Thermostat and Digital LED Temperature Display
- High Efficiency CFC Free Insulation
- Stainless Steel Front and Sides
- Self-Closing Door
- Magnetic Gasket can be Replaced without any Tools
- Heating Element Conceal in Door Frame to Eliminate any Condensation
- ⁴ Shelves per door
- Magnetic gasket can be replaced without any tool
- ³ year parts & labor warranty. ⁵ year compressor part warranty.



Glass Door Refrigerators



Item #	Description	Size	Price Ea.
● RR1G-HC**	¹ Door ²³ cu. ft. Refrigerator	26.8" W x 31.9" D x 82.7" H	\$
● RR2G-HC**	² Door ⁴⁹ cu. ft. Refrigerator	53.9" W x 31.9" D x 82.7" H	\$



Serv-Ware Commercial “Value Series”

Features & Benefits:

- White painted exterior finish with white ABS interior
- LED temperature display
- Heavy duty steel frame construction with food-safe ABS interior
- High efficiency CFC free insulation
- Field reversible door
- Glass door (ER²⁵G-HC)
- ⁴ adjustable shelves - ER(F)²⁵-HC & ER²⁵G-HC
- Ships with casters installed
- ETL sanitation approved - conforms to UL⁴⁷¹, CSA C^{22,2} and NSF ⁷ standards
- ¹ year parts & labor warranty.



“Value Series” Commercial Refrigerator

Item #	Description	Size	Price Ea.
● ER25-HC**	1 Door White Refrigerator	30.6" W x 28.8" D x 78" H	\$

“Value Series” Commercial Freezer - Self Defrosting

Item #	Description	Size	Price Ea.
● EF25-HC**	1 Door White Freezer	30.6" W x 28.8" D x 78" H	\$

“Value Series” Under Counter Refrigerator

Item #	Description	Size	Price Ea.
● ER5-HC**	1 Door ⁵ cu. ft. Refrigerator	23.6" W x 23.4" D x 33" H	\$

“Value Series” Under Counter Freezer

Item #	Description	Size	Price Ea.
● EF5-HC**	1 Door ⁵ cu. ft. Freezer	23.6" W x 23.4" D x 33" H	\$

Glass Door Merchandiser Refrigerators

Features & Benefits:

- Electronic thermostat and digital LED temperature display
- High efficiency CFC free insulation
- Self-closing, lockable door
- 3 shelves per door - GR(F)-¹² & GR(F)-¹⁶
- 4 shelves per door - GR(F)-²³ & GR(F)-⁴⁸ & GR(F)(S)-⁷²
- INTERIOR: Powder-coated steel white
- EXTERIOR: Powder-coated steel white, plastic top sign panel with lamp
- Stainless steel floor
- 3 year parts & labor warranty. 5 year compressor part warranty.



One Door Refrigerators

Item #	Description	Size	Price Ea.
GR12-HC	1 Door ¹² cu. ft. Refrigerator	25" W x 26" D x 61.8" H	\$
GR16-HC	1 Door ¹⁶ cu. ft. Refrigerator	25" W x 26" D x 74.8" H	\$
GR23-HC**	1 Door ²³ cu. ft. Refrigerator	27" W x 32" D x 79.5" H	\$



Two Door Refrigerator

Item #	Description	Size	Price Ea.
GR48-HC**	2 Door ⁴⁸ cu. ft. Glass Refrig.	54" W x 32" D x 79.5" H	\$

Two Door Sliding Refrigerator

Item #	Description	Size	Price Ea.
GR48S-HC**	2 Door ⁴⁸ cu. ft. Glass Slider	54" W x 30.7" D x 79.5" H	\$

Three Door Refrigerator

Item #	Description	Size	Price Ea.
GR72-HC**	3 Door ⁷² cu. ft. Glass Refrig.	81" W x 32" D x 79.5" H	\$

Three Door Sliding Refrigerator

Item #	Description	Size	Price Ea.
GR72S-HC**	3 Door ⁷² cu. ft. Glass Slider	81" W x 30.7" D x 79.5" H	\$



Glass Door Merchandiser Freezers

Features & Benefits:

- Electronic thermostat and digital LED temperature display
- High efficiency CFC free insulation
- Self-closing, lockable door
- Triple pane glass doors on freezer
- 3 shelves per door - GR(F)-12 & GR(F)-16
- 4 shelves per door - GR(F)-23 & GR(F)-48 & GR(F)(S)-72
- INTERIOR: Powder-coated steel white
- EXTERIOR: Powder-coated steel white, plastic top sign panel with lamp
- Stainless steel floor
- 3 year parts & labor warranty. 5 year compressor part warranty.



One Door Freezer



Item #	Description	Size	Price Ea.
● GF23-HC**	1 Door 23 cu. ft. Freezer	27" W x 32" D x 79.5" H	\$



Two Door Freezer

Item #	Description	Size	Price Ea.
● GF48-HC**	2 Door 49 cu. ft. Glass Freezer	54" W x 32" D x 79.5" H	\$



Three Door Freezer

Item #	Description	Size	Price Ea.
● GF72-HC**	3 Door 72 cu. ft. Glass Freezer	81" W x 32" D x 79.5" H	\$

*Single Phase 220 - 240 volts.

Sandwich Prep Tables

Features & Benefits:

- CFC free refrigerant & foam
- AISI 304 stainless steel framework construction
- Electronic thermostat & digital LED temperature display for accurate control & easy reading
- Auto defrosting & auto evaporation of condensation water
- Magnetic gaskets can be replaced without any tool
- PC plastic pans & plastic cutting board are included
- Unit ships with casters installed (2 brake & 2 non brake)
- 3 year parts & labor warranty. 5 year compressor part warranty.

Sandwich Prep Tables



Item #	Description	Size	Price Ea.
• SP29-8-HC**	8 Pan Prep Unit	29" W x 30" D x 43.2" H	\$
• SP36-8-HC**	10 Pan Prep Unit	36.2" W x 29.9" D x 43.2" H	\$
• SP48-12-HC***	12 Pan Prep Unit	48.2" W x 30" D x 43.2" H	\$
• SP60-16-HC***	16 Pan Prep Unit	61.2" W x 30" D x 43.2" H	\$
• SP72-18-HC	18 Pan Prep Unit	71.7" W x 30" D x 43.2" H	\$

New Overshelves Available:

- * SPOS-48 fits SP48-12-HC .
- * SPOS-60 fits SP60-16-HC.
- * See Page 34.

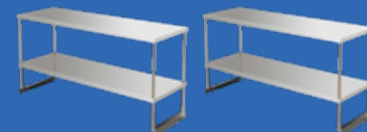

Mega Top Sandwich Prep Tables

Features & Benefits:

- CFC free refrigerant & foam
- AISI 304 stainless steel framework construction
- Electronic thermostat & digital LED temperature display for accurate control & easy reading
- Auto defrosting & auto evaporation of condensation water
- Magnetic gaskets can be replaced without any tool
- PC plastic pans & plastic cutting board are included
- Unit ships with casters installed (2 brake & 2 non brake)
- 3 year parts & labor warranty. 5 year compressor part warranty.

Mega Top Sandwich Prep Tables



Item #	Description	Size	Price Ea.
• SP29-12M-HC**	12 Pan Prep Unit	29" W x 30" D x 43.2" H	\$
• SP36-12M-HC**	15 Pan Prep Unit	36.4" W x 29.1" D x 43.3" H	\$
• SP48-18M-HC**	18 Pan Prep Unit	48.2" W x 30" D x 43.2" H	\$
• SP60-24M-HC**	24 Pan Prep Unit	61.2" W x 30" D x 43.2" H	\$
• SP72-27M-HC**	27 Pan Prep Unit	71.7" W x 30" D x 43.2" H	\$

Pizza Prep Tables

Features & Benefits:

- Electronic thermostat and digital LED temperature display
- Stainless steel front and sides
- Plastic pans and cutting board are included
- Magnetic gaskets
- Self closing doors with full length handle, remain open past 90°
- Unit ships with casters installed (2 brake & 2 non brake)
- 3 year parts & labor warranty. 5 year compressor part warranty.

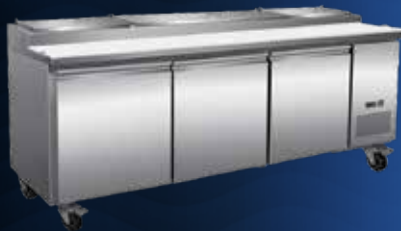
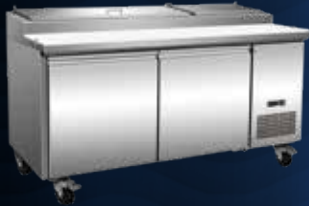

Pizza Prep Tables



Item #	Description	Size	Price Ea.
● PP44-6-HC***	6 Pan Prep Unit	47.4" W x 32.3" D x 41.3" H	\$
● PP67-9-HC***	9 Pan Prep Unit	70.8" W x 32.3" D x 41.3" H	\$
● PP93-12-HC	12 Pan Prep Unit	94.2" W x 32.3" D x 41.3" H	\$

New Overshelves Available:
 * PPOS-44 fits PP44-6-HC.
 * PPOS-67 fits PP67-9-HC.
 * See Page 34.

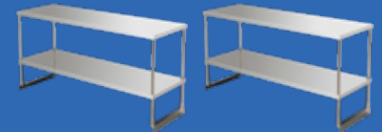

Chef Bases

Features & Benefits:

- CFC free refrigerant and foam
- Stainless steel framework construction
- Electronic thermostat and digital LED temperature display
- Auto defrosting and auto evaporation of condensation
- Magnetic gaskets
- Unit ships with casters installed (2 brake & 2 non brake)
- 1 year parts & labor warranty. Additional 4 year compressor part warranty.

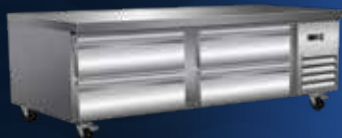
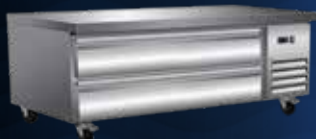
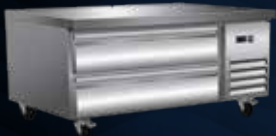

Chef Bases



Item #	Description	Size	Price Ea.
● CB36-HC**	2 Drawer 36 in. Chef Base	38" W x 31.9" D x 26" H	\$
● CB48-HC**	2 Drawer 48 in. Chef Base	50" W x 31.9" D x 26" H	\$
● CB60-HC**	2 Drawer 60 in. Chef Base	62" W x 31.9" D x 26" H	\$
● CB72-HC**	4 Drawer 72 in. Chef Base	74" W x 31.9" D x 26" H	\$



Undercounter Refrigerators

Features & Benefits:

- HC refrigerant
- CFC free refrigerant & foam
- AISI 304 stainless steel framework construction
- Electronic thermostat & digital LED temperature display for accurate control & easy reading
- Auto defrosting & auto evaporation of condensation water
- Magnetic gaskets can be replaced without any tool
- Unit ships with casters installed (2 brake & 2 Non brake)
- 3 year parts & labor warranty. 5 year compressor part warranty.

Undercounter Refrigerators



Item #	Description	Size	Price Ea.
● UCR-26-HC**	6.5 cu. ft. Refrigerator	27.5" W x 30" D x 31.5" H	\$
● UCR-27-HC**	6.5 cu. ft. Refrigerator	27.8" W x 29.9" D x 35.5" H	\$
● UCR-36-HC**	7.7 cu. ft. Refrigerator	36.4" W x 29.9" D x 35.5" H	\$
● UCR-48-HC**	12 cu. ft. Refrigerator	48.2" W x 29.9" D x 35.5" H	\$
● UCR-60-HC**	15.5 cu. ft. Refrigerator	61" W x 29.9" D x 35.5" H	\$
● UCR-72-HC**	18 cu. ft. Refrigerator	71.5" W x 29.9" D x 35.5" H	\$

Undercounter Freezers

Features & Benefits:

- HC refrigerant
- CFC free refrigerant & foam
- AISI 304 stainless steel framework construction
- Electronic thermostat & digital LED temperature display for accurate control & easy reading
- Auto defrosting & auto evaporation of condensation water
- Magnetic gaskets can be replaced without any tool
- Unit ships with casters installed (2 brake & 2 Non brake)
- 3 year parts & labor warranty. 5 year compressor part warranty.

Undercounter Freezers



Item #	Description	Size	Price Ea.
● UCF-26-HC**	6.5 cu. ft. Freezer	27.5" W x 30" D x 31.5" H	\$
● UCF-27-HC**	6.5 cu. ft. Freezer	27.8" W x 29.9" D x 35.5" H	\$
● UCF-36-HC**	7.7 cu. ft. Freezer	36.4" W x 29.9" D x 35.5" H	\$
● UCF-48-HC**	12 cu. ft. Freezer	48.2" W x 29.9" D x 35.5" H	\$
● UCF-60-HC**	15.5 cu. ft. Freezer	61" W x 29.9" D x 35.5" H	\$
● UCF-72-HC**	18 cu. ft. Freezer	71.5" W x 29.9" D x 35.5" H	\$

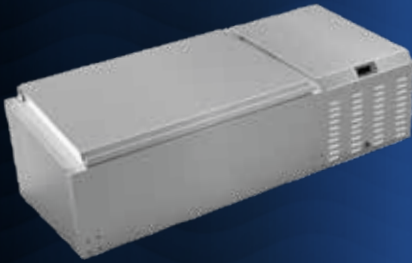

Top Rail Refrigerators

Features & Benefits:

- CFC free refrigerant and foam
- 1/4 pans included
- Interior: S/S ³⁰⁴
- Exterior: S/S ³⁰⁴
- 1 year parts & labor warranty. Additional 4 year compressor part warranty.



Top Rail Refrigerators

Item #	Description	Size	Price Ea.
• TR46-HC**	46 in. Unit	45.78" W x 17.44" D x 13.5" H	\$
• TR60-HC**	59 in. Unit	59.96" W x 17.44" D x 13.5" H	\$





Beer Dispensers

Features & Benefits:

- R²⁹⁰ HC refrigerant
- CFC free refrigerant and foam
- Electronic thermostat & digital LED temperature display for accurate
- Control & easy reading
- Self-closing door(s) with locks
- Adjustable heavy duty PVC coated shelves
- Magnetic gasket can be replaced without any tools
- Stainless steel top
- Interior: ⁴³⁰ stainless steel bottom, walls and ceiling
- Exterior: Corrosion resistant vinyl on steel in black
- Internal design accommodates a variety of beer kegs
- Installation board is removable for easy access to condenser coil
- 3" Diameter stainless steel insulated beer column. Designed to channel cold air directly into insulated beer column, thus maximizing your draft beer profits by reduced foaming.
- Ships with castors
- ³ year parts & labor warranty. ⁵ year compressor part warranty.

24" Direct Draw Beer Dispensers



Item #	Description	Size	Price Ea.
• DD24-1-HC**	24 in. Unit/1 Tower	24.1" W x 31.87" D x 38.66" H	\$
• DD49-1-HC**	49 in. Unit/1 Tower	49.1" W x 24.4" D x 36.4" H	\$
• DD49-2-HC**	49 in. Unit/2 Tower	49.1" W x 24.4" D x 36.4" H	\$
• DD61-1-HC**	61 in. Unit/1 Tower	61.06" W x 24.4" D x 36.4" H	\$
• DD61-2-HC**	61 in. Unit/2 Tower	61.06" W x 24.4" D x 36.4" H	\$
• DD73-2-HC**	73 in. Unit/2 Tower	73.07" W x 24.4" D x 36.4" H	\$

Glass Frosters

Features & Benefits:

- R²⁹⁰ HC refrigerant
- Forced-air cooling
- INTERIOR: Stainless Steel
- EXTERIOR: Steel painted black
- Chills glass and plate at -10°F
- Electronic thermostat & digital LED temperature display for accurate control & easy reading
- Two shelves and bottom rack standard
- Lockable top
- Built-in condensate evaporator system
- No floor drain or additional plumbing is needed
- ³ year parts & labor warranty. ⁵ year compressor part warranty.



Glass Frosters



Item #	Description	Size	Price Ea.
• GFR24**	24 in. Glass Froster	24.1" W x 27" D x 34.8" H	\$
• GFR36**	36 in. Glass Froster	36.9" W x 27" D x 34.8" H	\$



Bottle Coolers

Features & Benefits:

- R²⁹⁰ HC refrigerant
- CFC free refrigerant & foam
- Forced-air cooling
- Adjustable dividers included
- Self-defrosting evaporator
- Bottle cap opener & cap catcher standard
- Locking stainless steel sliding doors
- INTERIOR: Stainless steel
- EXTERIOR: Steel painted black stainless steel sliding doors & landing edge
- Ships with casters
- ³ year parts & labor warranty. ⁵ year compressor part warranty.



Bottle Coolers

Item #	Description	Size	Price Ea.
● BC-36-HC**	36 in. Unit	36.8" W x 27" D x 35" H	\$
● BC-50-HC**	49 in. Unit	49.4" W x 27" D x 35" H	\$
● BC-65-HC**	64 in. Unit	64.3" W x 27" D x 35" H	\$
● BC-95-HC**	95 in. Unit	95.3" W x 27" D x 35" H	\$

Backbar Bottle Coolers

Features & Benefits:

- R²⁹⁰ HC refrigerant
- CFC free refrigerant & foam
- Electronic thermostat & digital LED temperature display for accurate control & easy reading
- Self-closing door
- Magnetic gasket can be replaced without any tools
- Stainless steel top
- INTERIOR: ³⁰⁴ Stainless Steel
- EXTERIOR: Powder-coated steel black
- Ships with casters
- ³ year parts & labor warranty. ⁵ year compressor part warranty.



Solid Doors

Item #	Description	Size	Price Ea.
● BB2-24-HC**	49 in. Unit	49.1" W x 24.4" D x 36.2" H *	\$
● BB3-24-HC**	61 in. Unit	61.1" W x 24.4" D x 36.2" H *	\$
● BB4-24-HC**	73 in. Unit	73.1" W x 24.4" D x 36.2" H *	\$

* Height (H) WITHOUT Casters.

Glass Doors

Item #	Description	Size	Price Ea.
● BB2-24G-HC**	49 in. Unit	49.1" W x 24.4" D x 36.2" H *	\$
● BB3-24G-HC**	61 in. Unit	61.1" W x 24.4" D x 36.2" H *	\$
● BB4-24G-HC**	73 in. Unit	73.1" W x 24.4" D x 36.2" H *	\$

* Height (H) WITHOUT Casters.



Ranges 24" / 36" / 60"

Features & Benefits:

- SGR-4B 4 Open top burners, 1 oven
- SGR-6B 6 Open top burners, 1 oven
- SGR-6B-C 6 open top burners, 1 convection oven
- SGR-10B 10 Open top burners, 2 ovens
- 30,000 BTU per open top burner
- 31,000 BTU per oven with U-shaped burner
- Fully welded frame for stability
- Stainless steel front, back riser and galvanized sides
- Covered pilot and burner covers to prevent clogging from spillage
- Durable stainless steel pilot
- Easily removable heavy duty cast grates 1/2" x 12"
- Pull out crumb tray with rounded edges to prevent heat transfer
- 6" Adjustable heavy duty stainless steel legs
- Full size sheet pan fits side-to-side or front-to-back
- Oven thermostat adjusts from 250° to 550° F

Ranges



Item #	Description	Size	Price Ea.
SGR-4B	4 Burner 24" Range	24" W x 32.6" D x 60" H	\$
SGR-6B	6 Burner 36" Range	36" W x 32.6" D x 60" H	\$
SGR-6B-C	6 Burner 36" Range/Convection	36" W x 35" D x 60" H	\$
SGR-10B	10 Burner 60" Range	60" W x 32.6" D x 60" H	\$



Above range is natural gas and supplied with LP orifice kit.
 * Regulator is included.
 * Optional Caster Now Available (Brake Only, Sold Each). See page 20.
 * 3/4 in. Gas Inlet.



5SB - 4040



Ranges 36" / 60" with Griddles

Features & Benefits:

- SGR-²B-²⁴G ² Open top burners, ²⁴" griddle, ¹ oven
- SGR-⁴B-¹²G ⁴ Open top burners, ¹²" griddle, ¹ oven
- SGR-⁶B-²⁴G ⁶ Open top burners, ²⁴" griddle, ² ovens
- SGR-⁶B-²⁴RG ⁶ Open top burners, ²⁴" raised griddle w/broiler, ² ovens
- ^{30,000} BTU per open top burner
- ^{31,000} BTU per oven with U-shaped burner
- Fully welded frame for stability
- Stainless steel front, back riser and galvanized sides
- Covered pilot and burner covers to prevent clogging from spillage
- Durable stainless steel pilot
- Easily removable heavy duty cast grates¹²" x ¹²"
- Pull out crumb tray with rounded edges to prevent heat transfer
- ⁶" Adjustable heavy duty stainless steel legs
- Full size sheet pan fits side-to-side or front-to-back
- Oven thermostat adjusts from ²⁵⁰° to ⁵⁵⁰° F



Ranges With Griddle

Item #	Description	Size	Price Ea.
SGR-2B-24G	² Burner/ ²⁴ " Griddle	36" W x ^{32.6} " D x ⁶⁰ " H	\$
SGR-4B-12G	⁴ Burner/ ¹² " Griddle	36" W x ^{32.6} " D x ⁶⁰ " H	\$
SGR-6B-24G	⁶ Burner/ ²⁴ " Griddle	60" W x ^{32.6} " D x ⁶⁰ " H	\$
SGR-6B-24RG	⁶ Br/ ²⁴ " Raised Griddle/Broiler	60" W x ^{32.6} " D x ^{60.4} " H	\$

Above range is natural gas and supplied with LP orifice kit.

** Regulator is included.*

** Optional Caster Now Available (Brake Only, Sold Each). See page 20.*

** 3/4 in. Gas Inlet.*



5SB - 4040

Range Serv-Ware Select Series

Features & Benefits:

- Stainless steel panel and sides.
- ¹²" x ¹²" cast iron top grates designed for easy movement of pots across top sections.
- Deflectors to direct waste to crumb/drip pan.
- Large front panel, promoting safety and great functionality.
- Chrome plated injected aluminum knobs providing for better toughness and durability.
- Easily removable stainless steel crumb/drip pan.
- Oven with snap action thermostat from ²¹⁰°F to ⁵⁵⁰°F and ¹⁰⁰% safety shut off.
- ^{185,000} Total BTUs.
- ²⁶ ^{1/2}" Standard bakery depth on all ovens.
- Double-sided enamel oven cavity (Exterior and interior top, bottom, and side).
- Heavy-duty oven wired rack - ^{1/8}" diameter.
- The standard oven has ³ shelf positions and ¹ rack.
- Counterweight balanced doors.
- ¹-year parts and labor warranty.



Select Series Range

Item #	Description	Size	Price Ea.
SS-SGR-6B	⁶ Burner ³⁶ " Range	36" W x ³⁵ " D x ^{62.5} " H	\$

Add-On Portable Griddles

Features & Benefits:

- Portable Grill
- Heavy Duty 7 Gauge Stainless Steel
- ¾ lip on sides to prevent spillage



Item #	Description	Size	Price Ea.
PG1423	Portable Griddle 7GA Steel	14" W x 23" D x ¾" H	\$
PG1423S	Portable Griddle 7GA SS Steel	14" W x 23" D x ¾" H	\$
PG2323	Portable Griddle 7GA Steel	23" W x 23" D x ¾" H	\$
PG2323S	Portable Griddle 7GA SS Steel	23" W x 23" D x ¾" H	\$



Add-On Griddle Tops

Features & Benefits:

- Top fits on 2 burner commercial range
- 7 Gauge metal griddle pan
- 7 Gauge metal hooks
- 12 Ga. 304 stainless adjustable frame
- 12 Ga. aluminum handle bar
- 20 Ga. 304 stainless removable grease tray



Item #	Description	Size	Price Ea.
AG12	Add-On Griddle Top	12" W x 27" D x 4" H	\$
AG24	Add-On Griddle Top	24" W x 27" D x 4" H	\$

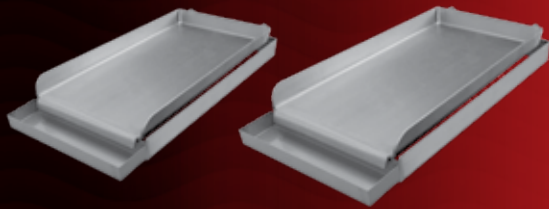

Add-On Broiler Tops

Features & Benefits:

- Top fits on 2 burner commercial range
- 7 Gauge metal griddle pan
- 7 Gauge metal hooks
- 12 Ga. 304 stainless adjustable frame
- 12 Ga. aluminum handle bar
- 20 Ga. 304 stainless removable grease tray



Item #	Description	Size	Price Ea.
AB12	Add-On Broiler Top	12" W x 27" D x 4" H	\$
AB24	Add-On Broiler Top	24" W x 27" D x 4" H	\$

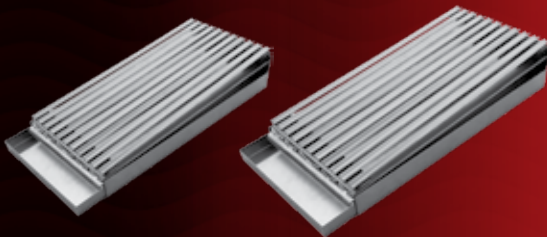

Add-On Griddle & Broiler Top

Features & Benefits:

- Top fits on 4 burner commercial range
- 7 Gauge metal griddle pan
- 7 Gauge metal hooks
- 12 Ga. 304 stainless adjustable frame
- 12 Ga. aluminum handle bar
- 20 Ga. 304 stainless removable grease tray



Item #	Description	Size	Price Ea.
ABG24SS	Add-On Griddle & Broiler Top	24" W x 27" D x 4" H	\$

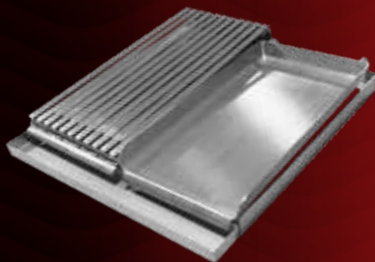



Cheesemelter

Features & Benefits:

- Gas infrared burner for better even heat distribution
- Extra large infrared burner to cover large cooking area
- Instant heating up, no need to pre-heat
- Standby pilot for easy start
- Three rack positions
- Chrome coating wiring grid
- Zinc alloy knob with chrome coating
- Oil collector at the bottom
- Wall mounting kit included for saving kitchen space
- Easy conversion from natural gas to propane
- Stainless steel in the front and sides
- Manual control



Cheesemelter



Item #	Description	Size	Price Ea.
SGCM-36	36" Gas Cheesemelter	36" W x 18.7" D x 22.8" H	\$

Salamander

Features & Benefits:

- Stainless steel structure
- 6" Cast iron burners
- Infrared burner can cook food faster
- Spring-balanced lifting system, easy to adjust
- Grills can be rolled out for easy loading, unloading, and cleaning
- Grill stopper to prevent grill falling off
- 5"-height locking position for different temperatures
- Continuous pilot for instant ignition of main burner
- Stainless steel crumb tray to collect dropped food
- Wall mounting kit included for saving kitchen space
- Can match 36" or 60" ranges (Kit to be ordered additionally)
- 3/4" NPT rear gas connection



Salamander



Item #	Description	Size	Price Ea.
SGSB-36	36" Gas Salamander	36" W x 19" D x 16.5" H	\$
** ONLY FITS **			
SGR-36-SMB-C	Mounting Kit	SGR-6B-C	\$
SGR-36-SMB	Mounting Kit	SGR-6B, SGR-2B-24G, SGR-4B-12G	\$
SGR-60-SMB	Mounting Kit	SGR-10B, SGR-6B-24G, SGR-6B-24RG	\$

Stock Pots

Features & Benefits:

- Cast iron burner
- Natural gas ^{110,000} BTU
- Propane gas (LP) ^{85,000} BTU
- Heavy duty cast iron grate
- Stainless steel front and sides
- Standby pilot for quick and easy start
- Zinc alloy knob
- Stainless steel adjustable legs
- Crumb tray at bottom
- Built for natural gas and supplied with LP conversion kit



Stock Pots

Item #	Description	Size	Price Ea.
SSSP-1	1 Burner	18" W x 24.6" D x 20.4" H	\$
SSSP-2	2 Burner	18" W x 49.3" D x 20.4" H	\$

* 3/4 in. Gas Inlet.



Convection Oven

Features & Benefits:

- ^{54,000} BTU per oven cavity
- Stainless front with fully visible glazed doors
- Porcelain interior for easy cleaning
- 4 Racks, ¹³ rack positions
- Automatic igniting system
- Solid state temperature controller
- ⁶⁰ Minute timer
- ^{120V} Dual speed motor
- Interior light
- Built for natural gas and supplied with LP conversion kit
- 3/4" Gas inlet size
- Single unit (SGCO-1) - Strong, stable angular legs, double stacking options
- Double stack unit - stacking kit with casters included (assembly required)



Convection Ovens

Item #	Description	Size	Price Ea.
SGCO-1	Single Deck	38.12" W x 43.2" D x 57.32" H	\$
STK-2	Stacking Kit for 2 Units		\$

* 3/4 in. Gas Inlet.

Fryers

Features & Benefits:

- 30,000 BTU per tube and thermostat with a temperature range of 200°F to 400°F
- Stainless steel front, top & header; sides & back galvanized steel
- Stainless steel door with integral liner & recessed handle
- Stainless steel fry tank with peened finish; cold zone in fry tank
- Double-rod stainless steel basket hanger
- 1-1/4" full-port drain valve for easy cleaning
- All fryers have drain tube racks and wire mesh fry baskets
- 6" stainless steel legs with 1" adjustability
- 1 year parts & labor warranty. 2 year pot part only warranty



5SB - 3535



3 Tube

Item #	Description	Size	Price Ea.
SGF-40N	³ Tube Natural ³⁵ to ⁴⁰ lbs.	15.5" W x 30.2" D x 46.5" H	\$
SGF-40L	³ Tube LP ³⁵ to ⁴⁰ lbs.	15.5" W x 30.2" D x 46.5" H	\$

* Regulator is included. * 3/4 in. hose required.

* 1/2 in. Gas Inlet.

* Optional Caster Now Available (Brake Only, Sold Each). See Page 20.

4 Tube

Item #	Description	Size	Price Ea.
SGF-50N	⁴ Tube Natural ⁵⁰ lbs.	15.5" W x 30.2" D x 46.5" H	\$
SGF-50L	⁴ Tube LP ⁵⁰ lbs.	15.5" W x 30.2" D x 46.5" H	\$

* Regulator is included. * 3/4 in. hose required.

* 1/2 in. Gas Inlet.

* Optional Caster Now Available (Brake Only, Sold Each). See Page 20.

5 Tube

Item #	Description	Size	Price Ea.
SGF-70N	⁵ Tube Natural ⁷⁵ to ⁸⁰ lbs.	21" W x 30.2" D x 46.5" H	\$
SGF-70L	⁵ Tube LP ⁷⁵ to ⁸⁰ lbs.	21" W x 30.2" D x 46.5" H	\$

* Regulator is included. * 3/4 in. hose required.

* 1/2 in. Gas Inlet.

* Optional Caster Now Available (Brake Only, Sold Each). See Page 20.



Fryers Serv-Ware Select Series

Features & Benefits:

- Tank - stainless steel providing durability for a high production output.
- Fully assembled flue.
- 1 1/4" Full port drain valve for fast draining.
- Cabinet - Stainless steel front, door and sides.
- Millivolt Thermostat, 200°F - 400°F
- High-Temperature safety limit switch.
- Thermo-Safety pilot with built-in regulator.
- Separate Manual gas shutoffs, for front servicing.
- Heavy-duty cast iron burners.
- Tubes constructed of heavy gauge metal.
- Heavy gauge deflector system providing a quicker recovery time.
- 2 heavy nickel plated baskets.
- Unique stainless steel crumb screen with handles.
- Drain Line Cleanout rod.
- Drainpipe extension.
- Removable stainless steel basket hanger requires no tools.
- 6" Adjustable chrome-plated legs.



SS-CASTER-KIT-6



3 Tube

Item #	Description	Size	Price Ea.
SS-SGF-40N	3 Tube Natural 40 lbs.	16" W x 33" D x 48.42" H	\$
SS-SGF-40L	3 Tube LP 40 lbs.	16" W x 33" D x 48.42" H	\$

* Regulator is included. * 3/4 in. hose required.

* 1/2 in. Gas Inlet.

* Optional Caster Kit Available (2 Brake, 2 Standard Sold as Kit). See Page 20.

4 Tube

Item #	Description	Size	Price Ea.
SS-SGF-50N	4 Tube Natural 50 lbs.	16" W x 33" D x 48.42" H	\$
SS-SGF-50L	4 Tube LP 50 lbs.	16" W x 33" D x 48.42" H	\$

* Regulator is included. * 3/4 in. hose required.

* 1/2 in. Gas Inlet.

* Optional Caster Kit Available (2 Brake, 2 Standard Sold as Kit). See Page 20.

5 Tube

Item #	Description	Size	Price Ea.
SS-SGF-70N	5 Tube Natural 75 lbs.	20" W x 33.7" D x 48.42" H	\$
SS-SGF-70L	5 Tube LP 75 lbs.	20" W x 33.7" D x 48.42" H	\$

* Regulator is included. * 3/4 in. hose required.

* 1/2 in. Gas Inlet.

* Optional Caster Kit Available (2 Brake, 2 Standard Sold as Kit). See Page 20.





Casters for Fryers & Ranges

Item #	Description	Price Ea.
5SB-3535	3 1/2" Optional Caster for Fryer (Brake Only, Sold Each)	\$
5SB-4040	4" Optional Caster for Range (Brake Only, Sold Each)	\$
SS-CASTER-KIT-6	Optional 6" Caster KIT	\$



Fryer Joiner Strip & Fryer Splash Guard

Item #	Description	Price Ea.
FJS	Fryer Joiner Strip SGF (40, 50, 70)	\$
FSG-1820-3	18" x 20.5" Fryer Splash Guard	\$



Hose / Restraining Kits & Gas Swivel

Item #	Description	Price Ea.
GHK-36	3/4" Fitting 36" Hose with Restraining Kit	\$
GHK-48	3/4" Fitting 48" Hose with Restraining Kit	\$
FS-SW-034	Gas Swivel	\$

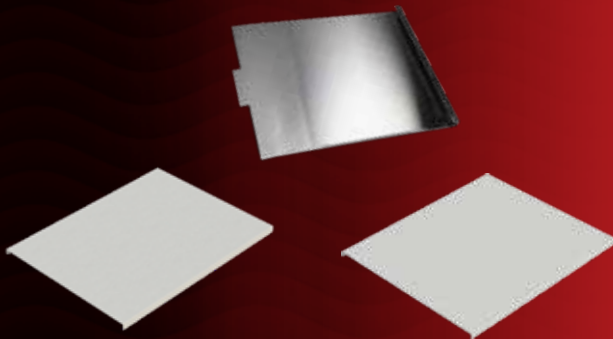

Tank Covers

Item #	Description	Price Ea.
TC-90/120	SGF (40, 50) Tank Cover	\$
TC-150	SGF-70 Tank Cover	\$
SS-TC-40/50	Optional SS-GF 40/50 Cover	\$
SS-TC-70	Optional SS-GF70 cover	\$

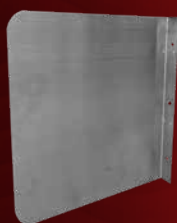

Wall Mount Sidesplashes



Item #	Description	Price Ea.
SSP-2420	24" x 20" Wall mount Sidesplash	\$
SSP-2428	24" x 28" Wall mount Sidesplash	\$
SSP-3020	30" x 20" Wall mount Sidesplash	\$
SSP-3028	30" x 28" Wall mount Sidesplash	\$

Radiant Charbroilers

Features & Benefits:

- 35,000 BTUs per burner provide intense heat
- Durable, attractive stainless steel construction
- Front edge is cool to the touch for safe cooking
- Stainless steel U-style burner optimizes heat control & distribution
- Heavy-duty 10-gauge stainless steel radiant for maximum heat distribution
- Cast iron grates can be adjusted for three different grilling positions
- Perfect for a variety of food on one unit
- Reversible cast iron grates make for varied grill marks
- Easily adjustable pilots with front access for quick lighting
- Back & side splashes offer protection against nasty spills
- Unit serviceable from the front
- Stainless steel legs have adjustable non-skid feet
- Ships ready for natural gas, LP conversion kit included



Radiant Charbroilers

Item #	Description	Size	Price Ea.
SCBS-24	2 Burner	24" W x 25.2" D x 15.3" H	\$
SCBS-36	3 Burner	36" W x 25.2" D x 15.3" H	\$
SCBS-48	4 Burner	48" W x 25.2" D x 15.3" H	\$

*Charbroilers are natural gas and supplied with LP conversion kit. * 3/4 in. Gas Inlet.*

Chef base sold on page 8.

Equipment stand sold on page 33.

** 30 in. deep equipment stand recommended.*

Hot Plates

Features & Benefits:

- 25,000 BTU per burner
- Durable, attractive, stainless steel construction
- Front edge is cool to the touch for safe cooking
- Octagonal burners provide even heat distribution
- Heavy-duty, cast iron grates for maximum heat distribution
- Full-length, seamless drip pan
- Adjustable pilots with front access
- Unit serviceable from the front
- Ships natural gas with an LP conversion kit
- Stainless steel legs have adjustable, non-skid feet



Hot Plates

Item #	Description	Size	Price Ea.
SHPS-12	2 Burner	12" W x 27.2" D x 11.28" H	\$
SHPS-24	4 Burner	24" W x 27.2" D x 11.28" H	\$
SHPS-36	6 Burner	36" W x 27.2" D x 11.28" H	\$

*Hot Plates are natural gas and supplied with LP conversion kit. * 3/4 in. Gas Inlet.*

Chef base sold on page 8.

Equipment stand sold on page 33.

** 30 in. deep equipment stand recommended.*

Manual Griddles

Features & Benefits:

- Steel U-shape burner, each ^{30,000} BTU/hr for better heat distribution
- One control every 12"
- Standby pilot for easy start
- 3/4" thickness griddle plate
- Stainless steel adjustable heavy duty legs
- Zinc alloy knob with chrome coating
- Oil collector at the bottom
- Easy conversion from natural gas to Propane or vice versa
- Stainless steel in the front and sides



Manual Griddles

Item #	Description	Size	Price Ea.
SMGS-12	¹ Burner	13.2" W x 25.2" D x 15.3" H	\$
SMGS-24	² Burner	24" W x 25.2" D x 15.3" H	\$
SMGS-36	³ Burner	36" W x 25.2" D x 15.3" H	\$
SMGS-48	⁴ Burner	48" W x 25.2" D x 15.3" H	\$
SMGS-60	⁵ Burner	60" W x 25.2" D x 15.3" H	\$

*Griddles are natural gas and supplied with LP conversion kit. * 3/4 in. Gas Inlet. Chef base sold on page 8.*

Equipment stand sold on page 33.

** 30 in. deep equipment stand recommended.*

Thermostatic Griddles

Features & Benefits:

- Cast iron H-shape burners
- ^{30,000} BTU per burner
- Thermostatic control
- Fully welded stainless back and side splash
- Standby pilot for quick and easy start
- Removable stainless steel drip tray
- Zinc alloy knob with chrome coating
- Stainless steel adjustable heavy duty legs
- Durable, attractive stainless steel front and sides
- Built for natural gas and supplied with LP conversion kit



Thermostatic Griddles

Item #	Description	Size	Price Ea.
STGS-12	¹ Burner	13.2" W x 25.2" D x 15.3" H	\$
STGS-24	² Burner	24" W x 25.2" D x 15.3" H	\$
STGS-36	³ Burner	36" W x 25.2" D x 15.3" H	\$
STGS-48	⁴ Burner	48" W x 25.2" D x 15.3" H	\$
STGS-60	⁵ Burner	60" W x 25.2" D x 15.3" H	\$

*Griddles are natural gas and supplied with LP conversion kit. * 3/4 in. Gas Inlet. Chef base sold on page 8.*

Equipment stand sold on page 33.

** 30 in. deep equipment stand recommended.*

Electric Thermostatic Griddles

Features & Benefits:

- Heavy duty stainless steel construction
- Stainless steel heating element for high efficiency
- ½" Steel cooking plate (ETG-16, ETG-24, ETG-30) 1" Steel cooking plate (ETG-36)
- Even heating/high heat retention
- Removable grease tray
- Indicator lights for power and heat
- Energy saving high output - highly efficient
- Adjustable 4" heavy duty stainless steel legs
- Temperature range 150°_570° F
- 1 year replacement part only warranty
- ETG-16, ETG-24 & ETG-30 power cord supplied.



Electric Thermostatic Griddles



Item #	Description	Size	Price Ea.
ETG-16	16"	16 14" W x 19 76" D x 9 40" H	\$
ETG-24	24"	24 13" W x 19 76" D x 9 40" H	\$
ETG-30	30"	30 15" W x 19 76" D x 9 40" H	\$
ETG-36*	36"	36 18" W x 19 76" D x 9 40" H	\$

** ETG-36 must be hardwired NO power cord supplied.*

ETG-36 ships 3 phase 208 volt.

Can be converted to single 220 - 240 volt.

Electric Panini Grills

Features & Benefits:

- For grilling/toasting both sides of bread such as panini sandwiches, grilled cheese sandwiches, wraps, quesadillas, toasting bread or garlic bread etc.
- Commercial construction/heavy duty stainless
- Adjustable temperature 120°_570° F
- Cast iron plates
- Removable crumb tray
- Cool touch handle
- Ready light and power light
- 6 month replacement part only warranty.



Electric Panini Griddles



Item #	Description	Size	Price Ea.
EPG-100GF	Single	16 92" W x 14 56" D x 8 26" H	\$
EPG-100GG	Single	16 92" W x 14 56" D x 8 26" H	\$
EPG-200GF	Double	22 44" W x 14 56" D x 8 26" H	\$
EPG-200GG	Double	22 44" W x 14 56" D x 8 26" H	\$

Electric Fryers

Features & Benefits:

- Stainless steel construction
- Stainless steel heating element for high efficiency Basin/¹ Basket (EF-⁰⁶L) and ² Basins/² Baskets (EF-⁰⁶L-²)
- Removable head
- Temperature range ¹²⁰°-³⁷⁵°F (High limit protection)
- ⁶ month replacement part only warranty.



Electric Fryers



Item #	Description	Size	Price Ea.
EF-06L	⁶ L/ ¹⁰ lbs.	9.84" W x 18.11" D x 14.56" H	\$
EF-06L-2	⁶ L + ⁶ L/ ²⁰ lbs.	20.86" W x 18.11" D x 14.56" H	\$

Hot Dog Steamers

Features & Benefits:

- Commercial stainless steel construction
- Pre-cooking time ¹⁵⁻⁴⁵ minutes
- Temperature range ⁸⁵°-¹⁷⁵°F
- Top loading for easy food accessibility
- Steam control plate
- Large ⁹ quart reservoir capacity
- Water removal by front drain valve
- Indicator lights for power and heating
- Energy saving high output - highly efficient
- ⁶ month replacement part only warranty
- ⁵ ft. cord and plug included ¹²⁰V, ¹⁴⁵⁰W



Hot Dog Steamers



Item #	Description	Size	Price Ea.
EHS-01	¹⁰⁰ Hot Dogs/ ⁴⁸ Buns	18.25" W x 14.25" D x 15.75" H	\$
EHS-02	²⁰⁰ Hot Dogs/ ⁶⁰ Buns	18.25" W x 14.25" D x 19.25" H	\$



Electric Convection Ovens

Features & Benefits:

- Holds ³, ¼" size sheet pans, not included (ECO-²¹)
- Holds ⁴, ½" size sheet pans, not included (ECO-⁴⁷, ECO-⁶⁶)
- Great for baking, warming and defrosting
- Heavy duty stainless steel interior and exterior
- Manual knob control
- 0-120 Minute timer
- Indication lights for power and when ready
- Dual wall - high performance double insulated
- Dual pane glass door
- Forced air convection - high efficiency
- Temperature range 150°-500° F
- Cool touch aluminum handle
- ³ Removable chrome wire racks included (ECO-²¹)
- ⁴ Removable chrome wire racks included (ECO-⁴⁷ & ECO-⁶⁶)
- ¹ year replacement part only warranty



Electric Convection Ovens

Item #	Description	Size	Price Ea.
ECO-21	¼ Size	18.625" W x 19.25" D x 14.875" H	\$
ECO-47	½ Size	22.875" W x 22" D x 15.875" H	\$
ECO-66	½ Size	22.875" W x 22" D x 20.125" H	\$

FLASHCHEF™



High Speed Oven Midea

Features & Benefits:

- Dual impingement for ultra fast browning and crisping on both sides of the food.
- Dual magnetron for high and consistent power output to save heating time.
- High Speed Oven uses Inverter Technology for the best microwave oven control.
- Precisely control and adjust power for proper heating.
- 8" HD TFT touch screen, largest screen in its class for easier reading.
- Intuitive and Icon control panel eliminates language barriers, just like operating a phone.
- Auto top menu function intelligently puts the frequently-used menu groups on top, for instant and convenient access.
- Built-in cavity light provides brighter and clearer sight inside the interior.
- Air Filters are easily removed and cleaned for maintenance.
- Large cavity accommodates a 12" (30cm) pizza with a space-friendly footprint.
- Stainless steel finish for easy maintenance and great appearance.



High Speed Oven

Item #	Description	Size	Price Ea.
G1	High Speed Oven	33.8" W x 18.7" D x 29.5" H	\$

Microwave Ovens 



Features & Benefits:

- Capacity (0.9 cu.ft./25 L), accommodates a 12" platter.
- Able to withstand the demands of the Commercial Food Service environment with stainless steel cabinet and oven cavity.
- 1000 Watts of Cooking power.
- Bottom energy feed.
- Full power only for simple operation.
- On door menu guide for frequently used items and reference.
- Chef/Test Kitchen Support.
- Oven cavity light to monitor cooking status without opening the door.
- EZ Grab'n Go door handle for reliable use, no moving parts.



Microwave Ovens

Item #	Description	Size	Price Ea.
1025F0A	Dial Timer	20.125" W x 17" D x 12.25" H	\$
1025F1A	Touch Pad	20.125" W x 17" D x 12.25" H	\$

Induction Cooktops 



Features & Benefits:

- Compact table top design with seamless stainless steel body.
- Slip-resistant metal feet.
- Easy to see front panel with adjustable control for easy operation.
- Dial control with 5 power levels and 24 hour timer.
- Sealed touch control provides consistent quality and makes cleaning easier.
- 5 cooling fans keep electronics cool.
- DC Silent Fans provide a comfortable cooking environment.
- 99% energy efficiency rating.
- Protective air deflector prevents hot exhaust and liquids from being pulled back into unit.
- Thermostatically controlled overheat sensor shuts the unit off to prevent damage to pans and overheating.
- Induction technology transfers heat to the pan, not to the surrounding air, allowing for cool operation.
- No pan, no heat. (MIC1800F)
- No Wok, no heat. (MIC3400WK) **A compatible wok pan is included with the MIC3400WK.*
- IPX3 water proof design.
- Sealed motherboard protects against damage.



Induction Cooktops

Item #	Description	Size	Price Ea.
MIC1800F	Induction Cooktop	14.2" W x 17.7" D x 5.1" H	\$
MIC3400WK	Induction Cooktop	14.8" W x 19.7" D x 7.4" H	\$



Heater Proofers

Features & Benefits:

- All welded heavy duty construction
- SC1836HP - Full size non-insulated
- SC1836HPI - Full size insulated
- UL approved PC clear door
- Door lifts off for easy cleaning and accessibility
- Control panel and easy-to-read LED display on removable bottom control drawer
- Proof mode adjusts humidity between 30% and 100% up to 115°F
- Heat mode with 9 adjustable settings can reach 185°F
- Perfect for storing a wide variety of ready-to-serve dishes
- 36 pan slides accept full size 18" x 26" sheet pans
- Seal in the heat with both magnets and tight-fitting gasket to proper temperature
- Requires a 120V, 1440W electrical connection 15 amp dedicated service
- Comes standard with cord and NEMA 5-15P plug
- Unit ships with casters (2 brake & 2 non brake)
- 1 year parts and labor warranty

Heater Proofers



Item #	Description	Size	Price Ea.
SC1836HP	Non-Insulated	21" W x 30.75" D x 68" H	\$
SC1836HPI	Insulated	21" W x 30.75" D x 68" H	\$



Convection Oven

Features & Benefits:

- High-efficiency oven with high-efficiency heating tube, direct forced hot-air system, 220V, 60Hz, one phase.
- Electronic temperature controller.
- Double layer heat-resistant glass doors and windows with chamber light.
- 60 minutes continuous bell timer, also can be manually cut off.
- 1/2-1/10HP two-speed air cooling fan & motor.
- With electric heating indicator light and power stand-by indicator light.
- Stainless steel chamber with arc angles.
- 11 removable grid rail, space 1 5/8", 3 chrome net frames.
- The top & front part are made of stainless steel.
- Black coating steel feet are adjustable.
- Independent stainless steel door, double-layer heat-resistant glass window, with separate door handles.
- Stainless steel door seal.
- Double equipment, superposition device.
- Hinged control panel installed in the front, easy to disassemble & repair.
- The top, side, back of the oven & the internal are made by industrial durable insulation materials.

Convection Oven



Item #	Description	Size	Price Ea.
SECO-2201	Electric Convec.Oven	38.11" W x 41.46" D x 54.09" H	\$





Warmer Drawers

Features & Benefits:

- Heavy duty stainless steel construction with 1/4" thick fiberglass sheet fully insulated.
- 11 gauge stainless steel drawer slides with 14 gauge slide brackets makes the drawer jam free.
- Accommodates standard size pans 12" x 20" x 4" (*Included), adjustable "pan supports" accommodates various pan sizes.
- Each drawer individually controlled by LED digital temperature controls to accurately monitor the temperature, indicator lamp and vent controls.
- Temperature range of 80° - 220°F.
- A unique heating system that provides consistent temperatures makes the food in it remain moist and flavorful for as long as possible.
- Available in 1-drawer, 2-drawer, and 3-drawer freestanding models.

Warmer Drawers



Item #	Description	Size	Price Ea.
*SWPWDS-1	1 Drawer Warmer	27.75" W x 21" D x 14.88" H	\$
*SWPWDS-2	2 Drawer Warmer	27.75" W x 21" D x 24.24" H	\$
*SWPWDS-3	3 Drawer Warmer	27.75" W x 21" D x 33.625" H	\$

- * SWPWDS-1: (1) pan included.
- * SWPWDS-2: (2) pans included.
- * SWPWDS-3: (3) pans included.



Chip Warmers

Features & Benefits:

- Door opens creating a shelf for scooping chips
- Sloping front of unit allows secure closure and easy opening
- Wide top opening doors for easy loading of chips
- Fan circulates air for quick and even heating
- Internal baffle minimizes chip breakage
- Fully removable front panel and bottom baffle for quick and easy cleaning
- Top doors, front panel and bottom baffle are removable without tools
- Durable stainless steel construction with high density insulation
- Adjustable rear-mounted thermostat
- Illuminated on/off switch
- Adjustable legs
- Furnished with power cord and NEMA 5-15 plug

Chip Warmers



Item #	Description	Size	Price Ea.
SWCW26	26 gal. Chip Warmer	26.46" W x 30.79" D x 30.32" H	\$
SWCW46	46 gal. Chip Warmer	26.46" W x 30.79" D x 37.8" H	\$



Hot Food Tables

Features & Benefits:

- Stainless heating elements
- Includes a ⁴³⁰ series stainless under shelf and a ²⁰¹ series stainless legs
- Adjustable stainless steel feet
- Open well bays accommodates standard size pans (**NOT Included*)
- Independent infinite controls
- ¹ Removable cutting board
- Designed to hold pre-cooked foods at safe hot food holding temperature
- ^{6'} Cord



3B-0050-B-HFT



Hot Food Tables

Item #	Description	Size	Price Ea.
EST3-1	1500 _W /120V	44" W x 29.5" D x 33.5" H	\$
EST4-1	2000 _W /120V	58.2" W x 29.5" D x 33.5" H	\$
EST4-2	3000 _W /220-240V	58.2" W x 29.5" D x 33.5" H	\$
EST5-2	3750 _W /220-240V	72.3" W x 29.5" D x 33.5" H	\$

**Double Sneeze Guard, Sanitary Guard and Cutting Board Kits available.
*Optional Insert Caster for Food Table Only (Brake Only, Sold Each).
See Page 56.*

Double Sneeze Guards

Features & Benefits:

- Stainless steel top
- Double sided sneeze guard
- ⁶ mm tempered glass guard
- Allows access to food on both sides

Item #	Description	Size	Price Ea.
SG3-2	Fits EST ³⁻¹	44" W x 10.6" D x 20" H	\$
SG4-2	Fits EST ⁴⁻¹ & EST ⁴⁻²	58.2" W x 10.6" D x 20" H	\$
SG5-2	Fits EST ⁵⁻²	72.3" W x 10.6" D x 20" H	\$

Sanitary Guards

Features & Benefits:

- Stainless steel top
- Single sided sneeze guard
- ⁶ mm tempered glass guard
- Allows access to food on one side

Item #	Description	Size	Price Ea.
SG3-1	Fits EST ³⁻¹	44" W x 10.6" D x 20" H	\$
SG4-1	Fits EST ⁴⁻¹ & EST ⁴⁻²	58.2" W x 10.6" D x 20" H	\$
SG5-1	Fits EST ⁵⁻²	72.3" W x 10.6" D x 20" H	\$

Cutting Board Kits

Features & Benefits:

- Includes stainless shelf, ² support brackets for shelf and cutting board
- Cutting board removes for easy cleaning

Item #	Description	Size	Price Ea.
CBK-3	Fits EST ³⁻¹	44" W x 7" D x 5/8" H	\$
CBK-4	Fits EST ⁴⁻¹ & EST ⁴⁻²	58.2" W x 7" D x 5/8" H	\$
CBK-5	Fits EST ⁵⁻²	72.3" W x 7" D x 5/8" H	\$





Planetary Dough Mixers

Features & Benefits:

- Gear driven, high torque transmission
- Three speeds
- Manual Timer (20 & 30 quart only)
- Heat-treated hardened steel alloy gears and shafts
- Permanently lubricated transmission
- Thermal overload protection
- Rigid cast iron body
- Stainless steel bowl guard
- Safety interlocked bowl guard and bowl lift
- Industry standard #12 attachment hub (20 & 30 quart only)
- 120 Volt NEMA 5-15P
- ETL listed
- Includes dough hook, beater & wire whip
- 1 year parts & labor warranty



Planetary Dough Mixers

Item #	Description	Size	Price Ea.
PM10LA	Planetary Dough Mixer	10 quart	\$
PM20-PTO	Planetary Dough Mixer	20 quart	\$
PM30-PTO	Planetary Dough Mixer	30 quart	\$

Slicer

Features & Benefits:

- 12" Hardened alloy knife for durability with dual stone knife sharpener
- Dial adjustable slice thickness (0" - 9/16")
- 1/3 HP fan cooled with thermal overload protection
- 120 Volt NEMA 5-15P
- Belt driven knife
- Non-slip feet
- Removable gravity feed angled chute with safety guard
- Fully covered electrical and belt drive area
- Stain resistant anodized aluminum finish
- Moisture proof ON/OFF switch
- 90 Days Labor - 1 Parts on Unit. Valid in United States



Slicer

Item #	Description	Size	Price Ea.
SLC-12	Slicer	12 in. blade	\$

***NOTE: Designed for medium volume continuous use with deli meats. NOT suitable for slicing cheese, frozen or raw meat.**





Standard Series Work Tables 18 Gauge 304 Stainless Top



Item #	Depth x Width	Price Ea.
T2424CWP-3	24" x 24"	\$
T2430CWP-3	24" x 30"	\$
T2436CWP-3	24" x 36"	\$
T2448CWP-3	24" x 48"	\$
T2460CWP-3	24" x 60"	\$
T2472CWP-3	24" x 72"	\$
T2496CWP-3	24" x 96" with 6 Legs	\$
T3015CWP-3	30" x 15" Filler Table	\$
T3018CWP-3	30" x 18" Filler Table	\$
T3024CWP-3	30" x 24"	\$
T3030CWP-3	30" x 30"	\$
T3036CWP-3	30" x 36"	\$
T3048CWP-3	30" x 48"	\$
T3060CWP-3	30" x 60"	\$
T3072CWP-3	30" x 72"	\$
T3096CWP-3	30" x 96" with 6 Legs	\$

18 gauge 304 stainless top with galvanized under shelf & galvanized legs.

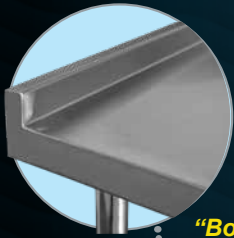

**"Boxed End"
Turn-up**



With 2" Turn-Up

Standard Series Work Tables with 2" Turnup 304 Stainless Top



Item #	Depth x Width	Price Ea.
T2424CWP-3-T	24" x 24"	\$
T2430CWP-3-T	24" x 30"	\$
T2436CWP-3-T	24" x 36"	\$
T2448CWP-3-T	24" x 48"	\$
T2460CWP-3-T	24" x 60"	\$
T2472CWP-3-T	24" x 72"	\$
T2496CWP-3-T	24" x 96" with 6 Legs	\$
T3015CWP-3-T	30" x 15" Filler Table	\$
T3018CWP-3-T	30" x 18" Filler Table	\$
T3024CWP-3-T	30" x 24"	\$
T3030CWP-3-T	30" x 30"	\$
T3036CWP-3-T	30" x 36"	\$
T3048CWP-3-T	30" x 48"	\$
T3060CWP-3-T	30" x 60"	\$
T3072CWP-3-T	30" x 72"	\$
T3096CWP-3-T	30" x 96" with 6 Legs	\$

18 gauge 304 stainless top with galvanized under shelf & galvanized legs.



Economy Series Work Tables
18 Gauge 430 Stainless Top



Item #	Depth x Width	Price Ea.
T1815CWP-4	18" X 15"	\$
T1824CWP-4	18" X 24"	\$
T1830CWP-4	18" X 30"	\$
T1836CWP-4	18" X 36"	\$
T1848CWP-4	18" X 48"	\$
T1860CWP-4	18" X 60"	\$
T1872CWP-4	18" X 72"	\$
T1896CWP-4	18" X 96"	\$
T2415CWP-4	24" X 15"	\$
T2424CWP-4	24" X 24"	\$
T2430CWP-4	24" X 30"	\$
T2436CWP-4	24" X 36"	\$
T2448CWP-4	24" X 48"	\$
T2460CWP-4	24" X 60"	\$
T3024CWP-4	30" X 24"	\$
T3030CWP-4	30" X 30"	\$
T3036CWP-4	30" X 36"	\$
T3048CWP-4	30" X 48"	\$
T3060CWP-4	30" X 60"	\$

18 gauge 430 stainless top with galvanized under shelf & galvanized legs.



Deluxe Series All Stainless Steel Work Tables
with 5" Backsplash



Item #	Depth x Width	Price Ea.
T3036CWP-16BS	30" X 36"	\$
T3048CWP-16BS	30" X 48"	\$
T3060CWP-16BS	30" X 60"	\$
T3072CWP-16BS	30" X 72"	\$

16 gauge 304 stainless top & 18 gauge 430 stainless under shelf & stainless legs.



Deluxe Series All Stainless Steel Work Tables



Item #	Depth x Width	Price Ea.
T3036CWP-16S	30" X 36"	\$
T3048CWP-16S	30" X 48"	\$
T3060CWP-16S	30" X 60"	\$
T3072CWP-16S	30" X 72"	\$

16 gauge 304 stainless top & 18 gauge 430 stainless under shelf & stainless legs.



Equipment Filler Table - 18 Gauge 430 Stainless Top



Item #	Depth x Width	Price Ea.
FTG-3012-4	30" D x 12" W x 34" H	\$
FTG-3015-4	30" D x 15" W x 34" H	\$
FTG-3018-4	30" D x 18" W x 34" H	\$
FTG-3024-4	30" D x 24" W x 34" H	\$

18 gauge 430 stainless top with galvanized under shelf & galvanized legs.

Economy Equipment Stands 30"



Item #	Depth x Width	Price Ea.
ESG3012W-CWP	30" D x 12" W x 24" H	\$
ESG3024W-CWP	30" D x 24" W x 24" H	\$
ESG3036W-CWP	30" D x 36" W x 24" H	\$
ESG3048W-CWP	30" D x 48" W x 24" H	\$
ESG3060W-CWP	30" D x 60" W x 24" H	\$
*ESG3072W-CWP	30" D x 72" W x 24" H	\$

*18 gauge 430 stainless top with galvanized under shelf & galvanized legs. * 6 Legs*



Deluxe Equipment Stands - All Stainless 24"



Item #	Depth x Width	Price Ea.
ESS2424W-CWP	24" D x 24" W x 24" H	\$
ESS2436W-CWP	24" D x 36" W x 24" H	\$
ESS2448W-CWP	24" D x 48" W x 24" H	\$
ESS2460W-CWP	24" D x 60" W x 24" H	\$
*ESS2472W-CWP	24" D x 72" W x 24" H with 6 Legs	\$

** 6 Legs*

30"



Item #	Depth x Width	Price Ea.
ESS3024W-CWP	30" D x 24" W x 24" H	\$
ESS3036W-CWP	30" D x 36" W x 24" H	\$
ESS3048W-CWP	30" D x 48" W x 24" H	\$
ESS3060W-CWP	30" D x 60" W x 24" H	\$
*ESS3072W-CWP	30" D x 72" W x 24" H with 6 Legs	\$

*16 gauge 304 stainless top with 18 gauge 430 stainless undershelf & stainless legs. * 6 Legs*



Over Shelf for Work Tables - 18 Gauge

NSF

Item #	Size	Price Ea.
OS-3E-CWP	36"	\$
OS-4E-CWP	48"	\$
OS-5E-CWP	60"	\$
OS-6E-CWP	72"	\$

18 gauge. *12 in. depth on all.

NEW ITEM!



Over Shelf for *Sandwich & *Pizza Prep Tables

NSF

Item #	Description	Depth x Width	Price Ea.
 PPOS-44	Overshelf (*ONLY Fits PP ⁴⁴ - ₆ -HC)	17.25" x 47.5"	\$
 PPOS-67	Overshelf (*ONLY Fits PP ⁶⁷ - ₉ -HC)	17.25" x 78.88"	\$
 SPOS-48	Overshelf (*ONLY Fits SP ⁴⁸ - ₁₂ -HC)	17.25" x 48.25"	\$
 SPOS-60	Overshelf (*ONLY Fits SP ⁶⁰ - ₁₆ -HC)	17.25" x 61.25"	\$

*PEASE NOTE! Only Fits Specific Products. See Spec Sheets for Details.

NEW ITEM!



Stainless Steel Drawers - 16 Gauge

NSF

Item #	Depth x Width	Price Ea.
SSD-24-CWP	For 24" Deep Worktables (fits 30" wide and up)	\$
SSD-30-CWP	For 30" Deep Worktables (fits 36" wide and up)	\$

16 gauge

Optional Legs & Casters for Tables, Dish Tables & Equipment Stands

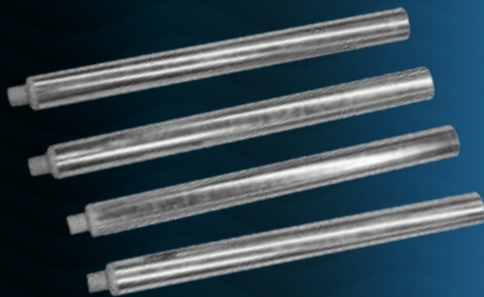

Item #	Description	Price Ea.
GTLS	Galvanized Legs for Tables (Set of 4)	\$
STLS	Stainless Steel Legs for Tables (Set of 4)	\$

*Optional Casters see Page 56.



48" Tables with Sink - 16 Gauge 304 Stainless



1 Bowl

Optional waste valve - see page. 46.

Item #	# of Bowls	Bowl W x D x H	Back Splash	Overall Length	Price Ea.
TSF-3048-L	1	16" x 20" x 12"	5"	48"	\$
TSF-3048-R	1	16" x 20" x 12"	5"	48"	\$

Table Size D x W x H

30" x 48" x 35.5"

16 Gauge 304 stainless top shelf, 16 Gauge 304 stainless 1 left / right fabricated tub. 18 Gauge 430 stainless hat channel, stainless leg and socket, stainless bullet feet. Rounded edge / bullnose edge. Deck-mounted faucet DFY12-CWP, 4" centers, swing nozzle, 12" long spout (low lead) included. 3.5" drain basket included.



60" Tables with Sink - 16 Gauge 304 Stainless



1 Bowl

Optional waste valve - see page 46.

Item #	# of Bowls	Bowl W x D x H	Back Splash	Overall Length	Price Ea.
TSF-3060-L	1	16" x 20" x 12"	5"	60"	\$
TSF-3060-R	1	16" x 20" x 12"	5"	60"	\$

Table Size D x W x H

30" x 60" x 35.5"

16 Gauge 304 stainless top shelf, 16 Gauge 304 stainless 1 left / right fabricated tub. 18 Gauge 430 stainless hat channel, stainless leg and socket, stainless bullet feet. Rounded edge / bullnose edge. Deck-mounted faucet DFY12-CWP, 4" centers, swing nozzle, 12" long spout (low lead) included. 3.5" drain basket included.



72" Tables with Sink - 16 Gauge 304 Stainless



1 Bowl

Optional waste valve - see pages 46.

Item #	# of Bowls	Bowl W x D x H	Back Splash	Overall Length	Price Ea.
TSF-3072-L	1	16" x 20" x 12"	5"	72"	\$
TSF-3072-R	1	16" x 20" x 12"	5"	72"	\$

Table Size D x W x H

30" x 72" x 35.5"

16 Gauge 304 stainless top shelf, 16 Gauge 304 stainless 1 left / right fabricated tub. 18 Gauge 430 stainless hat channel, stainless leg and socket, stainless bullet feet. Rounded edge / bullnose edge. Deck-mounted faucet DFY12-CWP, 4" centers, swing nozzle, 12" long spout (low lead) included. 3.5" drain basket included.

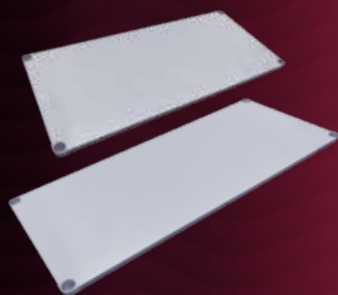

Undershelves (Extra) 48", 60", 72"



Item #	Size	Price Ea.
UTSF-3048	21.75" D x 41.5" W x 1.625" H	\$
UTSF-3060	21.75" D x 53.5" W x 1.625" H	\$
UTSF-3072	21.75" D x 65.5" W x 1.625" H	\$

18 Gauge 430 stainless undershelf with aluminum die cast clamp.

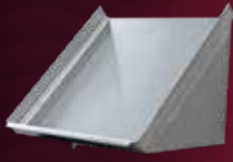

Slant Racks - 18 Gauge 304 Stainless



Item #	Size	Price Ea.
SR21-CWP	21"	\$
SR42-CWP	42"	\$
SR63-CWP	63"	\$
<i>18 gauge 304 stainless.</i>		

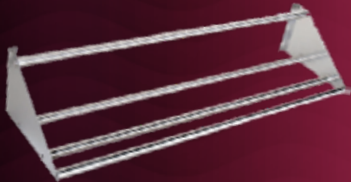

Tubular Slant Racks



Item #	Size	Price Ea.
SRT22-CWP	22"	\$
SRT42-CWP	42"	\$
SRT62-CWP	62"	\$
<i>16 gauge 430 stainless, 18 gauge support tubes.</i>		

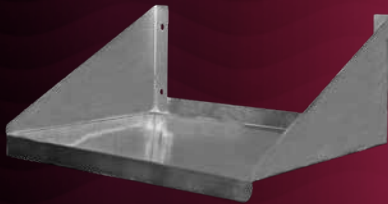

Microwave Shelves - 18 Gauge 304 Stainless



Item #	Size	Price Ea.
SSMS1824-CWP	18" X 24"	\$
SSMS2424-CWP	24" X 24"	\$
<i>18 gauge 304 stainless.</i>		

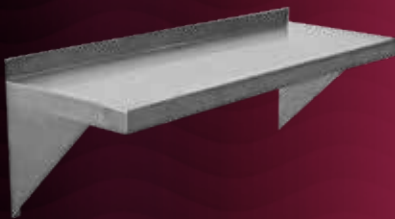

Wall Shelves - 18 Gauge 430 Stainless



12"		
Item #	D x W	Price Ea.
SSWS1224-CWP	12" X 24"	\$
SSWS1236-CWP	12" X 36"	\$
SSWS1248-CWP	12" X 48"	\$
SSWS1260-CWP	12" X 60"	\$
14"		
SSWS1424-CWP	14" X 24"	\$
SSWS1436-CWP	14" X 36"	\$
SSWS1448-CWP	14" X 48"	\$
SSWS1460-CWP	14" X 60"	\$
<i>18 gauge 430 stainless.</i>		



Pot Hook Racks - 304 Stainless

Single

Item #	Size	Price Ea.
SW1-24-CWP-8	24" Single Bar with 2 Hooks	\$
SW1-36-CWP-8	36" Single Bar with 3 Hooks	\$
SW1-48-CWP-8	48" Single Bar with 4 Hooks	\$
SW1-60-CWP-8	60" Single Bar with 5 Hooks	\$
SW1-72-CWP-8	72" Single Bar with 6 Hooks	\$
SW1-96-CWP-8	96" Single Bar with 8 Hooks	\$

Double

SW-24-CWP	24" Double Bar with 4 Hooks	\$
SW-36-CWP	36" Double Bar with 6 Hooks	\$
SW-48-CWP	48" Double Bar with 8 Hooks	\$
SW-60-CWP	60" Double Bar with 10 Hooks	\$
SW-72-CWP	72" Double Bar with 12 Hooks	\$
SW-96-CWP	96" Double Bar with 16 Hooks	\$

304 stainless.

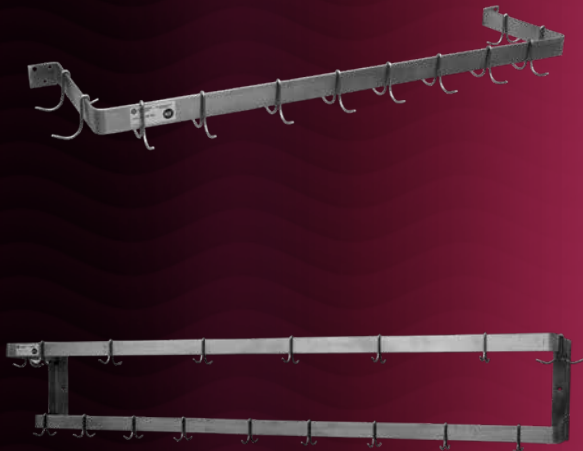

Hand Sinks - 18 Gauge 304 Stainless Top



Item #	# of Bowls	Bowl W x D	Bowl Depth	Price Ea.
HS10-CWP	1	9" x 9"	5"	\$
HS15-CWP	1	10" x 15"	5"	\$

Hand sink comes with faucet, basket strainer & mounting bracket 18 gauge 304 stainless top.

Hand Sinks with Splash Guard 18 Gauge 304 Stainless Top - 20 Gauge 304 Stainless Bowl



Left Splash Guard

Item #	# of Bowls	Bowl W x D	Bowl Depth	Price Ea.
HS10-CWP-SSL	1	9" x 9"	5"	\$
HS15-CWP-SSL	1	14" x 10"	5"	\$

Hand sink comes with faucet, basket strainer & mounting bracket.

Right Splash Guard

HS10-CWP-SSR	1	9" x 9"	5"	\$
HS15-CWP-SSR	1	14" x 10"	5"	\$

Hand sink comes with faucet, basket strainer & mounting bracket.

Double Splash Guard

HS10S-CWP	1	9" x 9"	5"	\$
HS15S-CWP	1	15" x 10"	5"	\$
HS15-CWP-SS		Wall mount Sidesplash	13" x 15"	\$

Hand sink comes with faucet, basket strainer & mounting bracket.



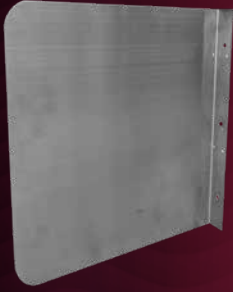

Splash Guards - 18 Gauge 304 Stainless



Item #	Description	W x H	Price Ea.
SSP-2420	Wall Mount Sidesplash	24" x 20"	\$
SSP-2428	Wall Mount Sidesplash	24" x 28"	\$
SSP-3020	Wall Mount Sidesplash	30" x 20"	\$
SSP-3028	Wall Mount Sidesplash	30" x 28"	\$

18 gauge 304 stainless.



Drop In Series with Faucet



1 Bowl					
<i>Comes with faucet.</i>					
Item #	# of Bowls	Bowl W x D	Bowl Depth	Overall Length	Price Ea.
DIS-1C10145-CWP	1	10" x 14"	5"	12"	\$
DIS-1C1014-CWP	1	10" x 14"	10"	12"	\$
2 Bowl					
DIS-2C1014-CWP	2	10" x 14"	10"	24"	\$
DIS-2C1416-CWP	2	14" x 16"	10"	33"	\$
DIS-2C2016-CWP	2	20" x 16"	10"	45"	\$
3 Bowl					
DIS-3C1014-CWP	3	10" x 14"	10"	36"	\$
DIS-3C1620-CWP	3	16" x 20"	10"	55"	\$

16 Gauge 304 Stainless Top - 18 Gauge 304 Stainless Bowl.



Compact Series - 18 Gauge 304 Stainless

Deli / Convenient Store Sink



3 Bowl						
<i>Optional waste valve - Faucets & drains see pages 45 & 46.</i>						
Item #	# of Bowls	Bowl W x D	Drain Board	Bowl Depth	Overall Length	Price Ea.
CS3CWP1410	3	10" x 14"	N/A	10"	39"	\$
CS3CWP1410L12	3	10" x 14"	12" Left DB	10"	48.5"	\$
CS3CWP1410R12	3	10" x 14"	12" Right DB	10"	48.5"	\$
CS3CWP1410212	3	10" x 14"	2) 12" DB	10"	58"	\$
CS3CWP1410218	3	10" x 14"	2) 18" DB	10"	70"	\$
CS3CWP1614212	3	14" x 16"	2) 12" DB	11"	70"	\$
CS3CWP2012212	3	12" x 20"	2) 12" DB	12"	64"	\$

18 Gauge 304 Stainless.



12" Deep Economy Series - 18 Gauge 304 Stainless



1 Bowl

Optional waste valve - Faucets & drains see pages 45 & 46.

Item #	# of Bowls	W x D	Drain Board	Overall Length	Price Ea.
D1CWP1620	1	16" x 20"	N/A	21"	\$
D1CWP1620L-18	1	16" x 20"	18" Left DB	36.5"	\$
D1CWP1620R-18	1	16" x 20"	18" Right DB	36.5"	\$
D1CWP16202-18	1	16" x 20"	2) 18" DB	52"	\$
D1CWP1818	1	18" x 18"	N/A	23"	\$
D1CWP1818L-18	1	18" x 18"	18" Left DB	38.5"	\$
D1CWP1818R-18	1	18" x 18"	18" Right DB	38.5"	\$
D1CWP18182-18	1	18" x 18"	2) 18" DB	54"	\$

2 Bowl

Optional waste valve - Faucets & drains see pages 45 & 46.

Item #	# of Bowls	W x D	Drain Board	Overall Length	Price Ea.
D2CWP1620	2	16" x 20"	N/A	37"	\$
D2CWP1620L-18	2	16" x 20"	18" Left DB	52.5"	\$
D2CWP1620R-18	2	16" x 20"	18" Right DB	52.5"	\$
D2CWP16202-18	2	16" x 20"	2) 18" DB	68"	\$
D2CWP1818	2	18" x 18"	N/A	41"	\$
D2CWP1818L-18	2	18" x 18"	18" Left DB	56.5"	\$
D2CWP1818R-18	2	18" x 18"	18" Right DB	56.5"	\$
D2CWP18182-18	2	18" x 18"	2) 18" DB	72"	\$

3 Bowl

Optional waste valve - Faucets & drains see pages 45 & 46.

Item #	# of Bowls	W x D	Drain Board	Overall Length	Price Ea.
D3CWP1620	3	16" x 20"	N/A	53"	\$
D3CWP1620L-18	3	16" x 20"	18" Left DB	68.5"	\$
D3CWP1620R-18	3	16" x 20"	18" Right DB	68.5"	\$
D3CWP16202-18	3	16" x 20"	2) 18" DB	84"	\$
D3CWP1818	3	18" x 18"	N/A	59"	\$
D3CWP1818L-18	3	18" x 18"	18" Left DB	74.5"	\$
D3CWP1818R-18	3	18" x 18"	18" Right DB	74.5"	\$
D3CWP18182-18	3	18" x 18"	2) 18" DB	90"	\$

18 Gauge 304 Stainless.



14" Deep Corner Series - 18 Gauge 304 Stainless



3 Bowl

Optional waste valve - Faucets & drains see pages 45 & 46.

Item #	# of Bowls	Bowl W x D	Drain Board	Bowl Depth	Overall Length	Price Ea.
*E3CWP18182-18-C	3	18" x 18"	2) 18" DB	14"	57" x 57"	\$
*E3CWP18182-24-C	3	18" x 18"	2) 24" DB	14"	63" x 63"	\$
*E3CWP24242-24-C	3	24" x 24"	2) 24" DB	14"	75" x 75"	\$

18 Gauge 304 Stainless. * Cut for 2 faucets.

14" Deep Economy Series
18 Gauge 304 Stainless



1 Bowl

Optional waste valve - Faucets & drains see pages 45 & 46.

Item #	# of Bowls	W x D	Drain Board	Overall Length	Price Ea.
E1CWP1818	1	18" x 18"	N/A	23"	\$
E1CWP1818L-18	1	18"x 18"	18" Left DB	38.5"	\$
E1CWP1818R-18	1	18" x 18"	18" Right DB	38.5"	\$
E1CWP18182-18	1	18" x 18"	2) 18" DB	54"	\$
E1CWP1818L-24	1	18" x 18"	24" Left DB	44.5"	\$
E1CWP1818R-24	1	18" x 18"	24" Right DB	44.5"	\$
E1CWP18182-24	1	18" x 18"	24" DB	66"	\$
E1CWP1824	1	18" x 24"	N/A	23"	\$
E1CWP18242-24	1	18" x 24"	2) 24" DB	66"	\$
E1CWP1824L-24	1	18" x 24"	24" Left DB	44.5"	\$
E1CWP1824R-24	1	18" x 24"	24" Right DB	44.5"	\$
E1CWP2424	1	24" x 24"	N/A	29"	\$
E1CWP2424L-24	1	24" x 24"	24" Left DB	50.5"	\$
E1CWP2424R-24	1	24" x 24"	24" Right DB	50.5"	\$
E1CWP3024	1	30" x 24"	N/A	35"	\$
E1CWP3624	1	36" x 24"	N/A	41"	\$

2 Bowl

Optional waste valve - Faucets & drains see pages 45 & 46.

E2CWP1818	2	18" x 18"	N/A	41"	\$
E2CWP1818L-18	2	18"x 18"	18" Left DB	56.5"	\$
E2CWP1818R-18	2	18" x 18"	18" Right DB	56.5"	\$
E2CWP18182-18	2	18" x 18"	2) 18" DB	72"	\$
E2CWP2424	2	24" x 24"	N/A	53"	\$
E2CWP2424L-24	2	24" x 24"	24" Left DB	74.5"	\$
E2CWP2424R-24	2	24" x 24"	24" Right DB	74.5"	\$
E2CWP24242-24	2	24" x 24"	2) 24" DB	96"	\$

3 Bowl

Optional waste valve - Faucets & drains see pages 45 & 46.

E3CWP1515	3	15" x 15"	N/A	50"	\$
E3CWP1515L-15	3	15"x 15"	15" Left DB	62.5"	\$
E3CWP1515R-15	3	15" x 15"	15" Right DB	62.5"	\$
E3CWP15152-15	3	15" x 15"	2) 15" DB	75"	\$
E3CWP1818	3	18" x 18"	N/A	59"	\$
E3CWP1818L-18	3	18" x 18"	18" Left DB	74.5"	\$
E3CWP1818R-18	3	18" x 18"	18" Right DB	74.5"	\$
E3CWP18182-18	3	18" x 18"	2) 18" DB	90"	\$
E3CWP18182-24	3	18" x 18"	2) 24" DB	102"	\$
E3CWP1824	3	18"x 24"	N/A	59"	\$
E3CWP1824L-18	3	18"x 24"	18" Left DB	74.5"	\$
E3CWP1824R-18	3	18"x 24"	18" Right DB	74.5"	\$
E3CWP1824L-24	3	18"x 24"	24" Left DB	80.5"	\$
E3CWP1824R-24	3	18"x 24"	24" Right DB	80.5"	\$
E3CWP18242-18	3	18"x 24"	2) 18" DB	90"	\$
E3CWP18242-24	3	18"x 24"	2) 24" DB	102"	\$
*E3CWP2424	3	24" x 24"	N/A	77"	\$
*E3CWP24242-24	3	24" x 24"	2) 24" DB	120"	\$

4 Bowl

Optional waste valve - Faucets & drains see pages 45 & 46.

*E4CWP16202-18	4	16" x 20"	18" DB	100"	\$
*E4CWP18242-24	4	18" x 24"	24" DB	120"	\$

18 Gauge 304 Stainless. * Cut for 2 faucets.

14" Deep Heavy Duty Series - 16 Gauge 304 Stainless



1 Bowl

Optional waste valve - Faucets & drains see pages 45 & 46.

Item #	# of Bowls	W x D	Drain Board	Overall Length	Price Ea.
1CWPH1818	1	18" x 18"	N/A	23"	\$
1CWPH1818L-18	1	18" x 18"	18" Left DB	38"	\$
1CWPH1818R-18	1	18" x 18"	18" Right DB	38"	\$
1CWPH18182-18	1	18" x 18"	2) 18" DB	54"	\$
1CWPH1824	1	18" x 24"	N/A	23"	\$
1CWPH1824L-18	1	18" x 24"	18" Left DB	39"	\$
1CWPH1824R-18	1	18" x 24"	18" Right DB	39"	\$
1CWPH1824L-24	1	18" x 24"	24" Left DB	46"	\$
1CWPH1824R-24	1	18" x 24"	24" Right DB	46"	\$
1CWPH18242-24	1	18" x 24"	2) 24" DB	66"	\$

3 Bowl

Optional waste valve - Faucets & drains see pages 45 & 46.

3CWPH18182-24	3	18" x 18"	2) 24" DB	106"	\$
3CWPH18242-24	3	18" x 24"	2) 24" DB	106"	\$
*3CWPH24242-24	3	24" x 24"	2) 24" DB	124"	\$
*3CWPH20282-30	3	20" x 28"	2) 30" DB	124"	\$

16 Gauge 304 Stainless. * Cut for 2 faucets.



14" Deep Heavy Duty Series - 14 Gauge 304 Stainless



1 Bowl

Optional waste valve - Faucets & drains see pages 45 & 46.

Item #	# of Bowls	Bowl W x D	Drain Board	Bowl Depth	Overall Length	Price Ea.
1C14H2448	1	48" x 24"	N/A	14"	53"	\$

3 Bowl

*3C14H20282-36	3	20" x 28"	2) 36" DB	14"	136"	\$
----------------	---	-----------	-----------	-----	------	----

16 Gauge 304 Stainless. * Cut for 2 faucets.



Basket with Slides - 16 Gauge 304 Stainless



Item #	W x D x H	Price Ea.
SSB2025-CWP	21.375" x 19.5" x 5"	\$

16 Gauge 304 Stainless.

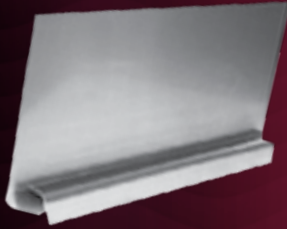

Removable Sink End Splash

Item #	Size	Price Ea.
RSS-18	1.75" D x 18" W x 12.25" H	\$
RSS-20	1.75" D x 20" W x 12.25" H	\$
RSS-24	1.75" D x 24" W x 12.25" H	\$
<i>18 Gauge 304 Stainless.</i>		

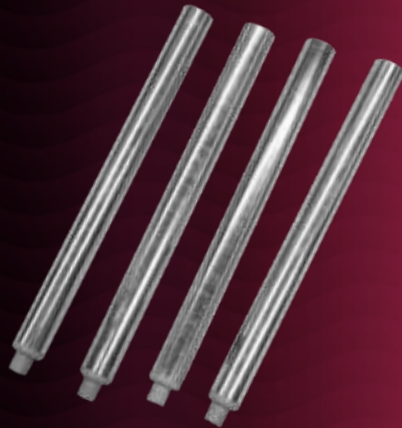

Optional Legs & Braces for Sinks & Dish Tables

Item #	Description	Price Ea.
*GSLK-1	Galvanized Leg Brace for 18" Sink (2 Bars, 4 Knuckles)	\$
*GSLK-2	Galvanized Leg Brace for 20" Sink (2 Bars, 4 Knuckles)	\$
*GSLK-3	Galvanized Leg Brace for 24" Sink (2 Bars, 4 Knuckles)	\$
*GSLK-4	Galvanized Leg Brace for 28" Sink (2 Bars, 4 Knuckles)	\$
GSL-14	Galvanized Legs for 14" Deep Sink (Set of 4)	\$
*SSLK-1	Stainless Steel Leg Brace for 18" Sink (2 Bars, 4 Knuckles)	\$
*SSLK-2	Stainless Steel Leg Brace for 20" Sink (2 Bars, 4 Knuckles)	\$
*SSLK-3	Stainless Steel Leg Brace for 24" Sink (2 Bars, 4 Knuckles)	\$
*SSLK-4	Stainless Steel Leg Brace for 28" Sink (2 Bars, 4 Knuckles)	\$
SLS	Stainless Steel Legs for 14" Deep Sinks (Set of 4)	\$
<i>*Leg sets sold separately. See pg. 34</i>		



Clean Dish Tables - 16 Gauge 304 Stainless



Item # (Left)	Item # (Right)	Overall Length	Price Ea.
CDT24L-CWP	CDT24R-CWP	24"	\$
CDT36L-CWP	CDT36R-CWP	36"	\$
CDT48L-CWP	CDT48R-CWP	48"	\$
CDT60L-CWP	CDT60R-CWP	60"	\$
CDT72L-CWP	CDT72R-CWP	72"	\$
<i>16 Gauge 304 Stainless.</i>			



Soiled Dish Tables - 16 Gauge 304 Stainless



Item # (Left)	Item # (Right)	Length	Price Ea.
DDT36L-CWP	DDT36R-CWP	36"	\$
DDT48L-CWP	DDT48R-CWP	48"	\$
DDT60L-CWP	DDT60R-CWP	60"	\$
DDT72L-CWP	DDT72R-CWP	72"	\$
<i>16 Gauge 304 Stainless.</i>			



Budget Sinks- 18 Gauge 430 Stainless Non NSF



1 Bowl

Optional waste valve - Faucets & drains see pages 45 & 46.

Item #	# of Bowls	Bowl W x D	Bowl Depth	Overall Length	Price Ea.
BS1-1818	1	18" x 18"	13"	21"	\$
BS1-1821	1	18" x 21"	13"	20"	\$
BS1-2424	1	24" x 24"	13"	27"	\$
BS1-3621	1	36" x 21"	13"	39"	\$
BS1-3624	1	36" x 24"	13"	39"	\$

2 Bowl

BS2-1818	2	18" x 18"	13"	39"	\$
BS2-1821	2	18" x 21"	13"	39"	\$
BS2-2424	2	24" x 24"	13"	51"	\$

3 Bowl

BS3-1221	3	12" x 21"	13"	39"	\$
BS3-1818	3	18" x 18"	13"	57"	\$
BS3-1821	3	18" x 21"	13"	57"	\$
BS3-2424	3	24" x 24"	13"	75"	\$

18 Gauge 430 Stainless.



Optional Drainboards for Budget Sink Only



Item #	Size	Price Ea.
DB-1818-4	18" x 18"	\$
DB-1821-4	18" x 21"	\$
DB-2421-4	24" x 21"	\$
DB-2424-4	24" x 24"	\$

18 Gauge 430 stainless.

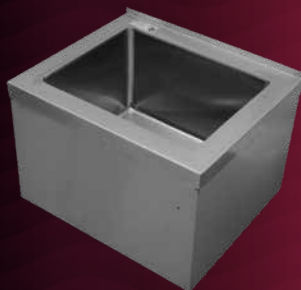

Mop Sinks - 18 Gauge



Item #	Size	Price Ea.
MS162012-CWP	25" x 21" x 16"	\$
MS202812-CWP	33" x 25" x 16"	\$

**Service faucet available on pg. 46*

Bar Series

18 Gauge 304 Stainless Top, Bowl & Back - 20 Gauge 304 Stainless Apron



1 Bowl

Faucets and overflow pipes sold separately, see below.

Item #	# of Bowls	Bowl W x D	Drain Board	Bowl Depth	Overall Length	Price Ea.
BAR1B14-CWP	1	10" x 14"	N/A	5"	14.5"	\$
BAR1B24-L-CWP	1	10" x 14"	12" Left DB	10"	24"	\$
BAR1B24-R-CWP	1	10" x 14"	12" Right DB	10"	24"	\$
BAR1B36-LR-CWP	1	10" x 14"	2) 12" DB	10"	36"	\$

2 Bowl

BAR2B26-CWP	2	10" x 14"	N/A	10"	26"	\$
BAR2B36-L-CWP	2	10" x 14"	12" Left DB	10"	36"	\$
BAR2B36-R-CWP	2	10" x 14"	12" Right DB	10"	36"	\$
BAR2B48-LR-CWP	2	10" x 14"	2) 13" DB	10"	48"	\$

3 Bowl

BAR3B38-CWP	3	10" x 14"	N/A	10"	38.5"	\$
BAR3B48-L-CWP	3	10" x 14"	12" Left DB	10"	48"	\$
BAR3B48-R-CWP	3	10" x 14"	12" Right DB	10"	48"	\$
BAR3B60-LR-CWP	3	10" x 14"	2) 13" DB	10"	60"	\$
BAR3B72-LR-CWP	3	10" x 14"	2) 19" DB	10"	72"	\$

4 Bowl

*BAR4B72-LR-CWP	4	10" x 14"	2) 13" DB	10"	72"	\$
-----------------	---	-----------	-----------	-----	-----	----

18 Gauge 304 Stainless Top, Bowl & Back - 20 Gauge 304 Stainless Apron. * Cut for 2 faucets.



Bar Sink Accessories



Item #	Description	Price Ea.
OFP-8-CWP	8" Overflow Pipe for Bar Sinks	\$
DTF4-6-CWP	4" Wall Mount Faucet with a 6" Spout	\$
DTF4-8-CWP	4" Wall Mount Faucet with a 8" Spout	\$
DTF4-10-CWP	4" Wall Mount Faucet with a 10" Spout	\$
DTF4-12-CWP	4" Wall Mount Faucet with a 12" Spout	\$
DTF4-14-CWP	4" Wall Mount Faucet with a 14" Spout	\$



Wall Mount Pre-Rinse

Item #	Description	Price Ea.
PRW8-CWP-E	8" Center, Economy	\$
PRW8-CWP	8" Center, Heavy Duty	\$

Deck Mount Pre-Rinse



Item #	Description	Price Ea.
PRS4-CWP	4" Center	\$

Add-On Faucet for Pre-Rinse



Item #	Description	Price Ea.
AF08-CWP	8" Spout	\$
AF12-CWP	12" Spout	\$
AF16-CWP	16" Spout	\$

For Models PRW8 & PRS4 Only.



Wall Mount Faucets



Item #	Description	Price Ea.
WF08-CWP	8" Spout	\$
WF10-CWP	10" Spout	\$
WF12-CWP	12" Spout	\$
WF14-CWP	14" Spout	\$
WF16-CWP	16" Spout	\$



Wall Mount Faucet Kit

Item #	Description	Price Ea.
WFMK-CWP	Wall Mount Faucet Kit	\$

** Needed for wall mounts & PR*



Hand Sink Faucet

NSF

Item #	Description	Price Ea.
*PFW4G-CWP	Replacement Faucet for Hand Sink or Other Wall Application	\$
<i>* For HS10 sink with sidesplash, requires FP1030</i>		



Deck Mount Faucets

NSF

Item #	Description	Price Ea.
DFY10-CWP	10" Spout	\$
DFY12-CWP	12" Spout	\$



Mop Sink Service Faucet

NSF

Item #	Description	Price Ea.
SF1000	8" Center	\$



Waste Valve with Overflow Cap

NSF

Item #	Description	Price Ea.
5D-35T-20A	Twist	\$
<i>Comes with Adapter.</i>		



Sink Drains & Basket

Item #	Description	Price Ea.
BS01-CWP	3.5" Drain Basket Strainer	\$
HS15-CWP-S	1.5" Drain Basket Strainer	\$



Replacement Hose

Item #	Description	Price Ea.
PR1010	44" Replacement Hose	\$



Replacement Spring

Item #	Description	Price Ea.
PR1020	44" Replacement Spring	\$



Lever Handle Repair Kit

Item #	Description	Price Ea.
FP1030	1 Pair	\$



Replacement Spray Valve

Item #	Description	Price Ea.
PR1000	Replacement Spray Valve	\$



Coupling Flanges

Item #	Description	Price Ea.
FP1300	Coupling Flanges, 1 Pair	\$

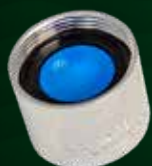

Faucet Pressure Aerator Nozzle

Item #	Description	Price Ea.
FP0015	1.5 GPM Flow Rate Nozzle	\$



Foot Valve

Item #	Description	Price Ea.
SSFV-CWP	Foot Valve	\$



Knee Valve

Item #	Description	Price Ea.
SSKV-CWP	Knee Valve	\$



Knee Valve with Goose Neck Faucet

Item #	Description	Price Ea.
SSKV-GF	Knee Valve with Goose Neck Faucet	\$



Spray Valve Repair Kit

Item #	Description	Price Ea.
FP1020	Fits Above Spray Valve	\$



Replacement Pre-Rinse Spindle

Item #	Description	Price Ea.
FP1040	Replacement Spindle	\$



Double Jointed Faucet

Item #	Description	Price Ea.
AF-18DJ-CWP	10" Double Jointed Faucet	\$

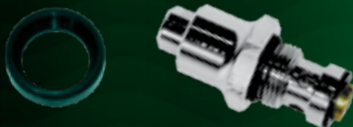

Pre-Rinse Accessories

Item #	Description	Price Ea.
PR1050-CWP	Spray Head Bumper	\$
PR1060-CWP	Button Valve Assembly	\$



Silver Epoxy Wire Shelving

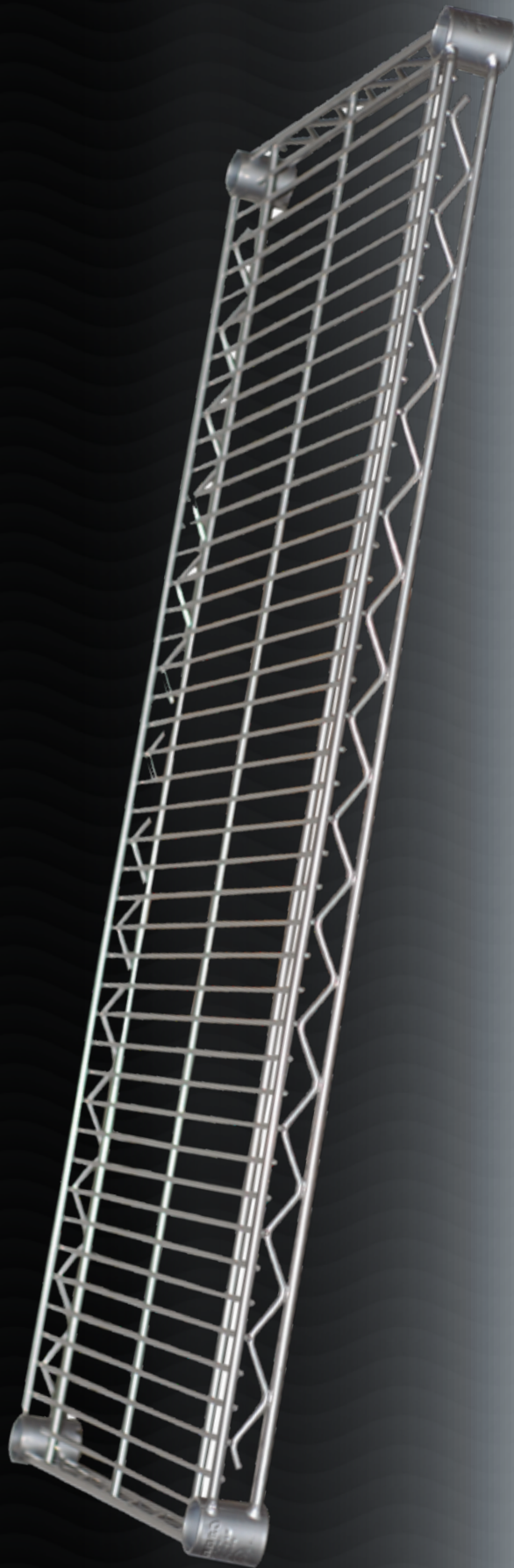

14"	Size	
Item #	D x W	Price Ea.
SL1424CWP	14" x 24"	\$
SL1430C		\$
SL1436CWP	14" x 36"	\$
SL1442C		\$
SL1448CWP	14" x 48"	\$
SL1454C		\$
SL1460CWP	14" x 60"	\$
SL1472C		\$
18"		
SL1824CWP	18" x 24"	\$
SL1830C		\$
SL1836CWP	18" x 36"	\$
SL1842C		\$
SL1848CWP	18" x 48"	\$
SL1854C		\$
SL1860CWP	18" x 60"	\$
SL1872C		\$
21"		
SL2124CWP	21" x 24"	\$
SL2130C		\$
SL2136CWP	21" x 36"	\$
SL2142C		\$
SL2148CWP	21" x 48"	\$
SL2154C		\$
SL2160CWP	21" x 60"	\$
SL2172C		\$
24"		
SL2424CWP	24" x 24"	\$
SL2430C		\$
SL2436CWP	24" x 36"	\$
SL2442C		\$
SL2448CWP	24" x 48"	\$
SL2454C		\$
SL2460CWP	24" x 60"	\$
SL2472C		\$
30"		
SL3036CWP	30" x 36"	\$
SL3048C		\$
SL3060CWP	30" x 60"	\$
SL3072C		\$



Silver Epoxy Wire

Item #	Size	Price Ea.
SL14CWP	14"	\$
SL34CWP		\$
SL54CWP	54"	\$
SL63CWP		\$
SL74CWP	74"	\$
SL86CWP		\$
<i>* Other wire accessories sold on page 54.</i>		

Silver Epoxy Wire

Item #	Size	Qty	Price Ea.
SLWB14-CWP	14" Single Bracket	2	\$
SLWB21-CWP	21" Single Bracket	2	\$
SLDWMB14-CWP	14" Double Bracket	1	\$
SLDWMB21-CWP	21" Double Bracket	1	\$

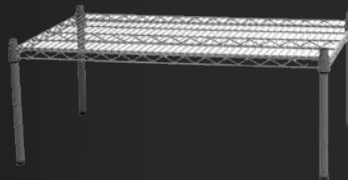
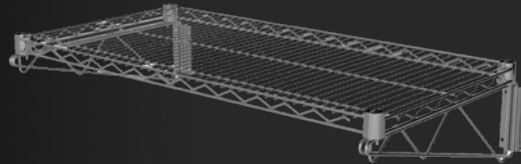
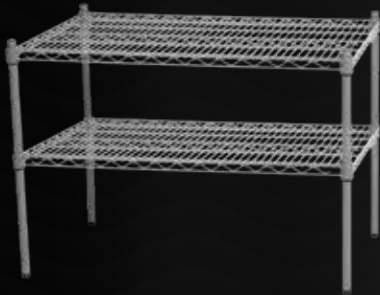

Creative Wire Shelving Configurations

Anti-Microbial

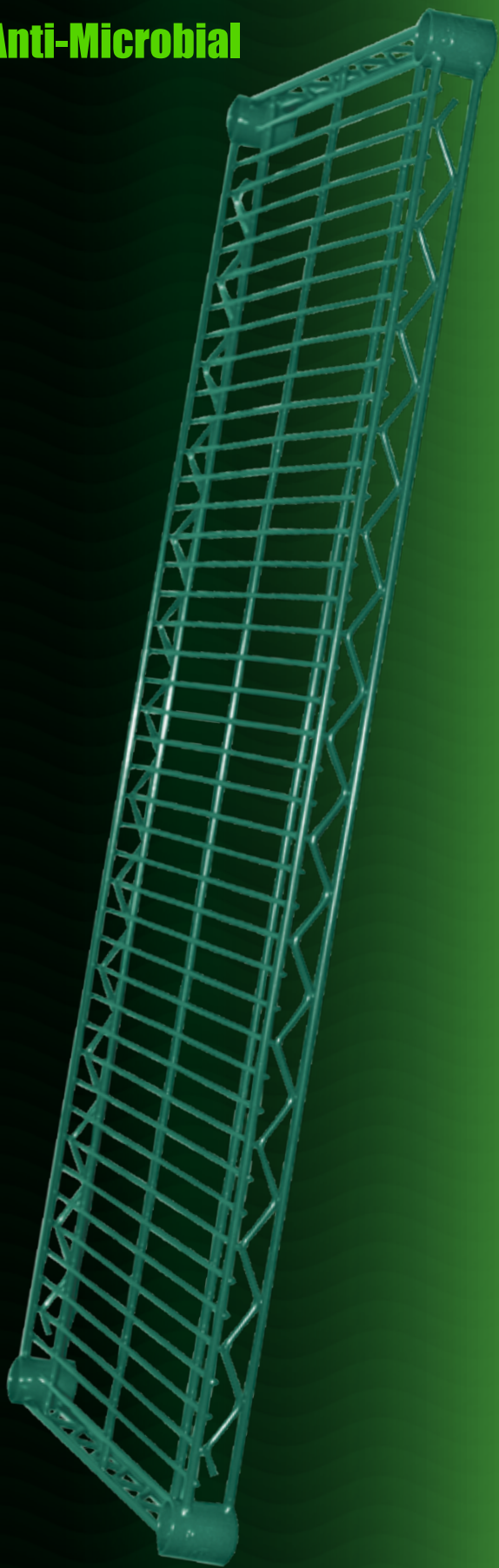

Green Epoxy Wire Shelving - 7 Year Warranty



14"		Size	
Item #	D x W		Price Ea.
GR1424CWP	14" x 24"		\$
GR1430CWP	14" x 30"		\$
GR1436CWP	14" x 36"		\$
GR1442CWP	14" x 42"		\$
GR1448CWP	14" x 48"		\$
GR1454CWP	14" x 54"		\$
GR1460CWP	14" x 60"		\$
GR1472CWP	14" x 72"		\$
18"			
GR1824CWP	18" x 24"		\$
GR1830CWP	18" x 30"		\$
GR1836CWP	18" x 36"		\$
GR1842CWP	18" x 42"		\$
GR1848CWP	18" x 48"		\$
GR1854CWP	18" x 54"		\$
GR1860CWP	18" x 60"		\$
GR1872CWP	18" x 72"		\$
21"			
GR2124CWP	21" x 24"		\$
GR2130CWP	21" x 30"		\$
GR2136CWP	21" x 36"		\$
GR2142CWP	21" x 42"		\$
GR2148CWP	21" x 48"		\$
GR2154CWP	21" x 54"		\$
GR2160CWP	21" x 60"		\$
GR2172CWP	21" x 72"		\$
24"			
GR2424CWP	24" x 24"		\$
GR2430CWP	24" x 30"		\$
GR2436CWP	24" x 36"		\$
GR2442CWP	24" x 42"		\$
GR2448CWP	24" x 48"		\$
GR2454CWP	24" x 54"		\$
GR2460CWP	24" x 60"		\$
GR2472CWP	24" x 72"		\$
30"			
GR3036CWP	30" x 36"		\$
GR3048CWP	30" x 48"		\$
GR3060CWP	30" x 60"		\$
GR3072CWP	30" x 72"		\$



Green Epoxy Post

Item #	Size	Price Ea.
GR14CWP	14"	\$
GR34CWP	34"	\$
GR54CWP	54"	\$
GR63CWP	63"	\$
GR74CWP	74"	\$
GR86CWP	86"	\$

** Other wire accessories sold on page 54.*

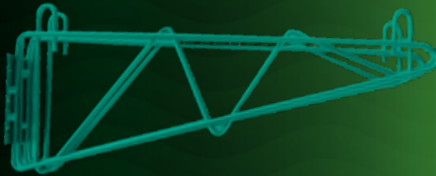

Green Epoxy Wall Brackets

Item #	Size	Qty	Price Ea.
GRWB14-CWP	14" Single Bracket	2	\$
GRWB18-CWP	18" Single Bracket	2	\$
GRWB21-CWP	21" Single Bracket	2	\$
GRWB24-CWP	24" Single Bracket	2	\$
GRDWMB14-CWP	14" Double Bracket	1	\$
GRDWMB18-CWP	18" Double Bracket	1	\$
GRDWMB21-CWP	21" Double Bracket	1	\$
GRDWMB24-CWP	24" Double Bracket	1	\$

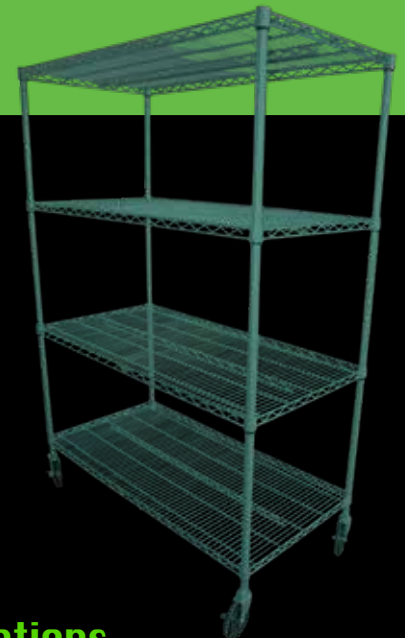
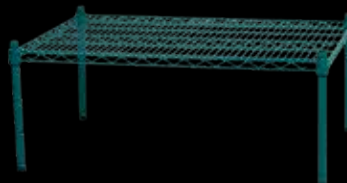
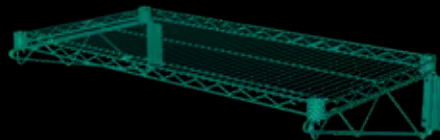
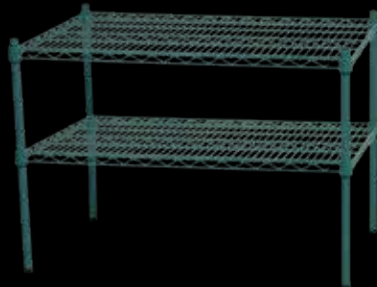

Creative Wire Shelving Configurations



Chrome Wire Shelving - 1 Year Warranty



18"		
Item #	Size D x W	Price Ea.
CH1824CWP	18" x 24"	\$
CH1836CWP	18" x 36"	\$
CH1848CWP	18" x 48"	\$
CH1860CWP	18" x 60"	\$
CH1872CWP	18" x 72"	\$
24"		
CH2424CWP	24" x 24"	\$
CH2436CWP **	24" x 36"	\$
CH2448CWP **	24" x 48"	\$
CH2460CWP	24" x 60"	\$
CH2472CWP	24" x 72"	\$

*** Fits Security Cages.*



Chrome Wall Brackets

Item #	Size	Qty	Price Ea.
CHWB18-CWP	18" Single Bracket	2	\$
CHWB24-CWP	24" Single Bracket		\$
CHDWMB18-CWP	18" Double Bracket	1	\$
CHDWMB24-CWP	24" Double Bracket		\$



Chrome Posts



Item #	Size	Price Ea.
CH63CWP	63"	\$
CH74CWP	74"	\$
CH86CWP	86"	\$

** Other wire accessories sold on page 54.*

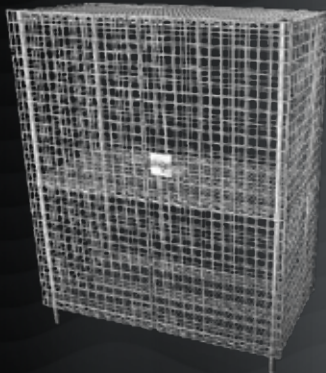

Security Cages



Item #	Description	Price Ea.
SC36SL-CWP	36" W x 24" D x 63" H	\$
SC48SL-CWP	48" W x 24" D x 63" H	\$

** Other wire accessories sold on page 54.*

*** CH2436CWP & CH2448CWP Fits. Additional casters available. Part # HRC-05 see pg. 54. Additional shelves available. See first section on current page above.*

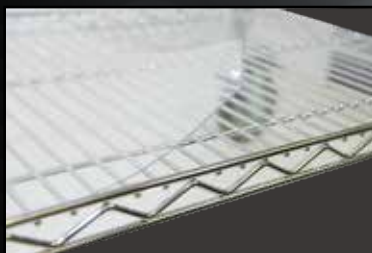
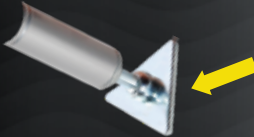

Post Cap

Item #	Description	Price Ea.
CWP-PC	Sold Each	\$

Post Leveler

Item #	Description	Price Ea.
CWP-PL	Sold Each	\$

Foot Plate

Item #	Description	Price Ea.
CWP-FP	Sold Each	\$

Shelf Clips - Set of 4

Item #	Description	Price Ea.
CWP-SC-E	Epoxy Shelving Only	\$
CWP-SC-C	Chrome Shelving Only	\$

Physically identical items.

S Hooks

Item #	Description	Price Ea.
CWP-SH	Set of 4	\$

3" Label Holders

Item #	Description	Price Ea.
ABM3	Sold Each	\$

5" Caster Set : Two Brake, Two Non-Brake

Item #	Description	Price Ea.
HRC-05	Heavy Duty 5" Caster with Rubber Bumper	\$

** For wire shelving only.*

Clear PVC Shelf Mats

Item #	D x W	Price Ea.
SMC1836CWP	18" x 36"	\$
SMC1848CWP	18" x 48"	\$
SMC1872CWP	18" x 72"	\$
SMC2436CWP	24" x 36"	\$
SMC2448CWP	24" x 48"	\$
SMC2472CWP	24" x 72"	\$



Aluminum Pan Racks

NSF

Item #	Description	Price Ea.
CWP-APR-10EL	10 Tier w/ Casters	\$
CWP-APR-20EL	20 Tier w/ Casters	\$

** Ships flat.*

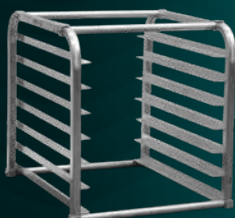
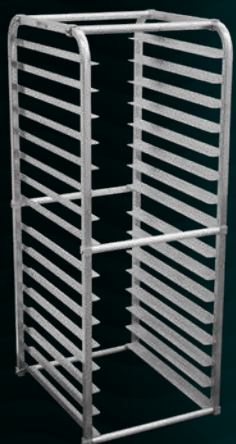

Aluminum Refrigerator Pan Racks

NSF

Item #	Description	Price Ea.
CWP-RR-07	7 Pan	\$
CWP-RR-16	15 Pan	\$

** Ships flat. Can not put casters on these racks.*

Aluminum Dunnage Racks

NSF

Item #	Size	Price Ea.
CWP-DR-203612	20" D x 36" W x 12" H	\$
CWP-DR-204812	20" D x 48" W x 12" H	\$
CWP-DR-206012	20" D x 60" W x 12" H	\$
CWP-DR-243612	24" D x 36" W x 12" H	\$
CWP-DR-244812	24" D x 48" W x 12" H	\$
CWP-DR-246012	24" D x 60" W x 12" H	\$

** Ships as shown.*





Insert Casters

Item #	Size	Price Ea.
3B-0050-B HFT	3" Wheel 1 ³ / ₈ " Insert <i>For Hot Tables Only</i>	\$
4B-0050	4" Wheel 1 ³ / ₈ " Insert	\$
4B-0050-B	4" Wheel 1 ⁵ / ₈ " Insert	\$
5B-0050	5" Wheel 1 ³ / ₈ " Insert	\$
5B-0050-B	5" Wheel 1 ⁵ / ₈ " Insert <i>For Tables Only</i>	\$

Polypropylene wheel, polyurethane hub.

Universal Plate Casters for Fryer & Range

Item #	Size	Price Ea.
5SB-3535	3 ¹ / ₂ " Plate Casters w/ Brake	\$
5SB-4040	4" Plate Caster w/ Brake	\$

Hard rubber.



5SB - 3535
Fryer

5SB - 4040
Range

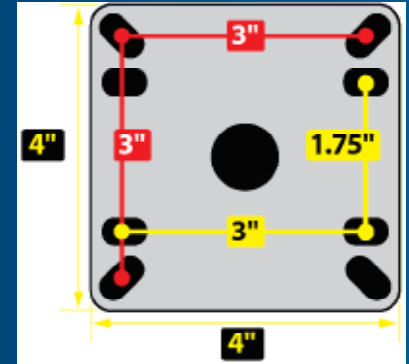
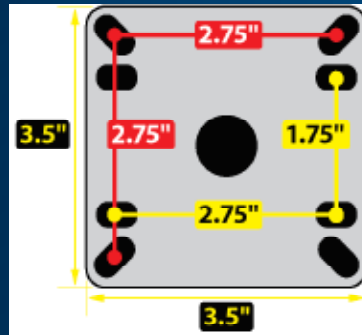

Grey Thermoplastic Foot Insert

Item #	Size	Price Ea.
1FI-HPL-01	1 ⁵ / ₈ "	\$

** For Tables & Sinks.*



Stainless Steel Adjustable Foot Insert

Item #	Size	Price Ea.
1FI-HSS02	1 ⁵ / ₈ "	\$

** For Tables & Sinks.*





Stainless Steel Hood Filters

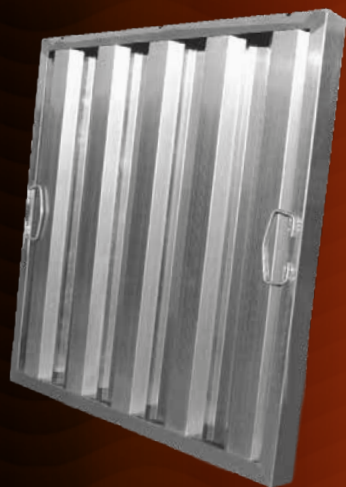

Item #	Size		Price Ea.
	H x W		
F1016S	10" x 16"		\$
F1020S	10" x 20"		\$
F1216S	12" x 16"		\$
F1220S	12" x 20"		\$
F1225S	12" x 25"		\$
F1616S	16" x 16"		\$
F1620S	16" x 20"		\$
F1625S	16" x 25"		\$
F2016S	20" x 16"		\$
F2020S	20" x 20"		\$
F2025S	20" x 25"		\$
F2516S	25" x 16"		\$
F2520S	25" x 20"		\$

Packed in Cases of 6.



3 Tier Plastic Bus Cart

Item #	Size	Price Ea.
BC-100B-CWP	16" D x 28" W x 38" H	\$



3 Tier Stainless Steel Carts



Item #	Description	Price Ea.
UC-1630S3A	24 Gauge, 16" x 30"	\$
UC-1834M3A	24 Gauge, 18" x 34"	\$
UC-2037L3B	22 Gauge, 20" x 37"	\$

201 stainless steel.

Serv-Ware Products Trade Terms & Conditions

PRICING

All prices are subject to change without notice. Order placed for future delivery may be subject to change. We are not responsible for any printers' errors. Possession of our Price List or Net Flyer does not constitute an offer to sell.

ORDERS & BACK ORDERS

Serv-Ware Products does not have a minimum order charge. We do not have an order cutoff time; we strive to ship every order the same day. We accept orders by phone, fax or email, which ever is most convenient for your company. Any duplication of orders not marked "confirmation" is the responsibility of your company. Back orders do not qualify for Free Freight unless it meets the requirements stated above. Email all purchase orders to sw-info@servware.com

RETURN POLICY

Returns will not be accepted without prior authorization from our customer service department. All returns must show the return authorization number on the shipping label or packing slip. Merchandise returned without an authorization number will not be accepted. Return merchandise must be in saleable condition. Credit will not be issued for used, obsolete or shelf worn merchandise. All authorized returns must be sent freight prepaid and will be subject to minimum of 25% restocking fee. On items returned after 30 days of invoice, the restocking fee will be at our discretion. Items older than 6 months of invoice date are not eligible for return. Free Freight orders are credited less freight cost.

ACCOUNT TERMS

Payment terms are net 30 days for approved customers. Contact customer service for credit application. New accounts please allow 3 to 5 business days to check credit. A 1.5% per month service charge will be applied to all invoices 30 days or more past due. The buyer agrees to pay all applicable attorney and collection fees. A \$50 charge will be issued for returned checks. We will not accept any charge backs or penalties deducted from payment without written authorization from our corporate office.

WARRANTY

Visit our website at www.servware.com or see individual spec sheets for details.



SERV-WARETM

Freight Policy

\$6,000 + Net

*WA, OR, MT, ND,
SD, ID, WY, CA,
& NV*

\$3,500 + Net

*UT, AZ, CO, NM,
NE, TX, KS, OK,
MN, IA, MO, AR,
LA, WI, IL, MI, IN,
KY, TN, MS, AL,
OH, WV, PA, VA,
NC, SC, GA, FL,
VT, ME, NH, MA,
RI, CT, NJ, DE,
& MD*



FREE FREIGHT PROGRAM

Serv-Ware Products LLC offers free freight on qualifying orders, as per the above map, unless otherwise specified. Items must be in stock at the time of purchase and must ship from one location to one destination, within the continental United States. No free freight on backorders is allowed, freight charges will be added to your invoice. You can however combine your backorders (once available) with other items to qualify for the free freight allowance. We reserve the right to choose the shipper.

Any additional service such as; lift-gate, notification of delivery, inside delivery or other special requirements will be subject to an additional charge to your invoice. Any charges from freight companies that arise due to incorrect addresses provided by the customer or rejected shipments that were previously approved will be charged back to your account.



\$6,000 + Net
for Free Freight

\$3,500 + Net
for Free Freight

FREIGHT CLAIM

Before accepting any shipment, inspect it carefully and note any damage or shortage on the freight bill before signing for the delivery. If any concealed damage or shortage is found, notify the carrier within five days and request an inspection. Report any damage to Serv-Ware Products within five days of delivery. Retain the original packaging for claim purposes. Serv-Ware Products is not liable for any damage or loss. **Our responsibility for shipment ceases with acceptance of the " Bill of Lading" by the carriers.**

www.servware.com
Call: 800.768.5953 or Fax: 800.976.1299



222 Hwy 58 South
Kinston, NC 28504



2025 PRODUCT CATALOG

CALL TOLL FREE 800.768.5953

FAX TOLL FREE 800.976.1299

Please Email Purchase Orders to: sw-info@servware.com

Scan code to visit our website and to download product spec sheets or the current List Price catalog.

